



Service Manual

Models: GWH09YD-D3DNA1A
GWH12YD-D3DNA1A
(Refrigerant R410A)

Table of Contents

Part I : Technical Information	1
1. Summary	1
2. Specifications	2
2.1 Specification Sheet.....	2
2.2 Operation Characteristic Curve	6
2.3 Capacity Variation Ratio According to Temperature	6
2.4 Cooling and Heating Data Sheet in Rated Frequency	7
2.5 Noise Curve.....	7
3. Outline Dimension Diagram	8
3.1 Indoor Unit.....	8
3.2 Outdoor Unit.....	9
4. Refrigerant System Diagram	10
5. Electrical Part	11
5.1 Wiring Diagram.....	11
5.2 PCB Printed Diagram	13
6. Function and Control	15
6.1 Remote Controller Introduction	15
6.2 Operation of Smart Control (Smart Phone, Tablet PC) For Gree	20
6.3 Operation of Smart Control (Smart Phone, Tablet PC)	33
6.4 Brief Description of Modes and Functions.....	46
Part II : Installation and Maintenance	51
7. Notes for Installation and Maintenance	51
8. Installation	53
8.1 Installation Dimension Diagram.....	53
8.2 Installation Parts-checking	55
8.3 Selection of Installation Location.....	55
8.4 Electric Connection Requirement	55
8.5 Installation of Indoor Unit.....	55
8.6 Installation of Outdoor Unit.....	58
8.7 Vacuum Pumping and Leak Detection	59
8.8 Check after Installation and Test Operation	59
8.9 Wired Controller	60

2. Specifications

2.1 Specification Sheet

Model			GWH09YD-D3DNA1A	
Product Code			CB437001200	
Power Supply	Rated Voltage	V~	208/230	
	Rated Frequency	Hz	50/60	
	Phases		1	
Power Supply Mode			Outdoor	
Cooling Capacity(Min~Max)		Btu/h	9000(1535~12996)	
Heating Capacity(Min~Max)		Btu/h	9000(2388~13648)	
Cooling Power Input(Min~Max)		W	540(50~1400)	
Heating Power Input(Min~Max)		W	590(200~1500)	
Cooling Power Current		A	3.05	
Heating Power Current		A	3.15	
Rated Input		W	1500	
Rated Current		A	6.2	
Air Flow Volume(SH/H/MH/M/ML/L/SL)		CFM	720/650/600/550/500/450/350	
Dehumidifying Volume		Pint/h	0.8	
EER		(Btu/h)/W	16.5	
COP		(Btu/h)/W	15.25	
SEER			38	
SCOP			15	
Application Area		yd ²	12-18	
Indoor Unit	Model of indoor unit		GWH09QD-D3DND6A/I	
	Indoor Unit Product Code		CB437N01200	
	Fan Type		Cross-flow	
	Diameter Length(DXL)		inch	Φ4 1/6X27 1/2
	Fan Motor Cooling Speed (SH/H/MH/M/ML/L/SL/Q)		r/min	1200/1100/1030/960/890/820/750/500
	Fan Motor Heating Speed (SH/H/MH/M/ML/L/SL/Q)		r/min	1300/1200/1120/1040/960/880/800/-
	Output of Fan Motor		W	60
	Fan Motor RLA		A	0.09
	Fan Motor Capacitor		μF	/
	Evaporator Form			Aluminum Fin-copper Tube
	Pipe Diameter		inch	Φ1/4
	Row-fin Gap		inch	2-1/16
	Coil Length (LXDXW)		inch	28 13/16X1X12
	Swing Motor Model			MP35CJ/MP24HF
	Output of Swing Motor		W	2.5/1.5
	Fuse		A	3.15
	Sound Pressure Level (SH/H/MH/M/ML/L/SL)		dB (A)	43/40/38/36/33/31/19
	Sound Power Level (SH/H/MH/M/ML/L/SL)		dB (A)	53/50/48/46/43/41/29
	Dimension (WXHXD)		inch	39 13/64X11 55/64X8 55/64
	Dimension of Carton Box (LXWXH)		inch	41 39/64X14 5/6X12
Dimension of Package (LXWXH)		inch	41 3/4X15X12 43/64	
Net Weight		lb	29.8	
Gross Weight		lb	36.4	

Outdoor Unit	Model of Outdoor Unit		GWH09YD-D3DNA1A/O	
	Outdoor Unit Product Code		CB437W01200	
	Compressor Manufacturer/Trademark		ZHUHAI LANDA COMPRESSOR CO., LTD	
	Compressor Model		QXAT-B121zE070	
	Compressor Oil		FV50S	
	Compressor Type		Rotary	
	Compressor L.R.A.	A		35
	Compressor RLA			6.9
	Compressor Power Input	W		1070
	Overload Protector			1NT11L-6233/HPC115/95/KSD115°C
	Throttling Method			Electron expansion valve
	Operation temp	°F		61~86
	Ambient temp (cooling)	°F		0~115
	Ambient temp (heating)	°F		-22~75
	Condenser Form			Aluminum Fin-copper Tube
	Pipe Diameter	inch		Φ9/32
	Rows-fin Gap	inch		2.5-1/18
	Coil Length (LXDXW)	inch		30.0X2 1/4X21 7/10
	Fan Motor Speed	rpm		800/500
	Output of Fan Motor	W		30
	Fan Motor RLA	A		0.24
	Fan Motor Capacitor	μF		/
	Air Flow Volume of Outdoor Unit	CFM		2400
	Fan Type			Axial-flow
	Fan Diameter	inch		Φ17 1/4
	Defrosting Method			Automatic Defrosting
	Climate Type			T1
	Isolation			I
	Moisture Protection			IPX4
	Design Pressure(High)	PSIG		550
	Design Pressure(Low)	PSIG		240
	Sound Pressure Level (H/M/L)	dB (A)		53/-/-
	Sound Power Level (H/M/L)	dB (A)		63/-/-
Dimension (WXHXD)	inch		35 3/8X23 1/2X14 7/8	
Dimension of Carton Box (LXWXH)	inch		37 3/16X16 7/16X24 13/16	
Dimension of Package (LXWXH)	inch		37 5/16X16 9/16X25 3/8	
Net Weight	lb		99.2	
Gross Weight	lb		105.8	
Refrigerant			R410A	
Refrigerant Charge	oz		49.4	
Connection Pipe	Length	ft	24.6	
	Gas Additional Charge	oz/ft	0.2	
	Outer Diameter Liquid Pipe	inch	1/4	
	Outer Diameter Gas Pipe	inch	1/2	
	Max Distance Height	ft	32.8	
	Max Distance Length	ft	49.2	
	Note:The connection pipe applies metric diameter.			

The above data is subject to change without notice; please refer to the nameplate of the unit.

Model			GWH12YD-D3DNA1A
Product Code			CB437000900
Power Supply	Rated Voltage	V~	208/230
	Rated Frequency	Hz	50/60
	Phases		1
Power Supply Mode			Outdoor
Cooling Capacity(Min~Max)		Btu/h	12000(2900~15354)
Heating Capacity(Min~Max)		Btu/h	12200(3071~18766)
Cooling Power Input(Min~Max)		W	785(75~1500)
Heating Power Input(Min~Max)		W	940(250~1600)
Cooling Power Current		A	3.9
Heating Power Current		A	5.3
Rated Input		W	1600
Rated Current		A	6.5
Air Flow Volume(SH/H/MH/M/ML/L/SL)		CFM	850/800/750/600/550/450/400
Dehumidifying Volume		Pint/h	2.96
EER		(Btu/h)/W	15.3
COP		(Btu/h)/W	12.98
SEER			30.5
SCOP			14
Application Area		yd ²	19.14-28.70
Indoor Unit	Model of indoor unit		GWH12YD-D3DNA1A/I
	Indoor Unit Product Code		CB437N00900
	Fan Type		Cross-flow
	Diameter Length(DXL)		inch Φ4 3/16X27 1/2
	Fan Motor Cooling Speed (SH/H/MH/M/ML/L/SL/Q)		r/min 1400/1300/1200/1100/1000/900/800/550
	Fan Motor Heating Speed (SH/H/MH/M/ML/L/SL/Q)		r/min 1400/1270/1200/1130/1050/980/900/-
	Output of Fan Motor		W 60
	Fan Motor RLA		A 0.09
	Fan Motor Capacitor		μF /
	Evaporator Form		Aluminum Fin-copper Tube
	Pipe Diameter		inch Φ1/4
	Row-fin Gap		inch 2-1/16
	Coil Length (LXDXW)		inch 28 13/16X1X12
	Swing Motor Model		MP35CJ/MP24HF
	Output of Swing Motor		W 2.5/1.5
	Fuse		A 3.15
	Sound Pressure Level (SH/H/MH/M/ML/L/SL)		dB (A) 49/46/43/40/37/34/30
	Sound Power Level (SH/H/MH/M/ML/L/SL)		dB (A) /
	Dimension (WXHXD)		inch 39 13/64X11 55/64X8 55/64
	Dimension of Carton Box (LXWXH)		inch 41 39/64X14 5/6X12
Dimension of Package (LXWXH)		inch 41 3/4X15X12 43/64	
Net Weight		lb 29.8	
Gross Weight		lb 36.4	

2.2 Operation Characteristic Curve

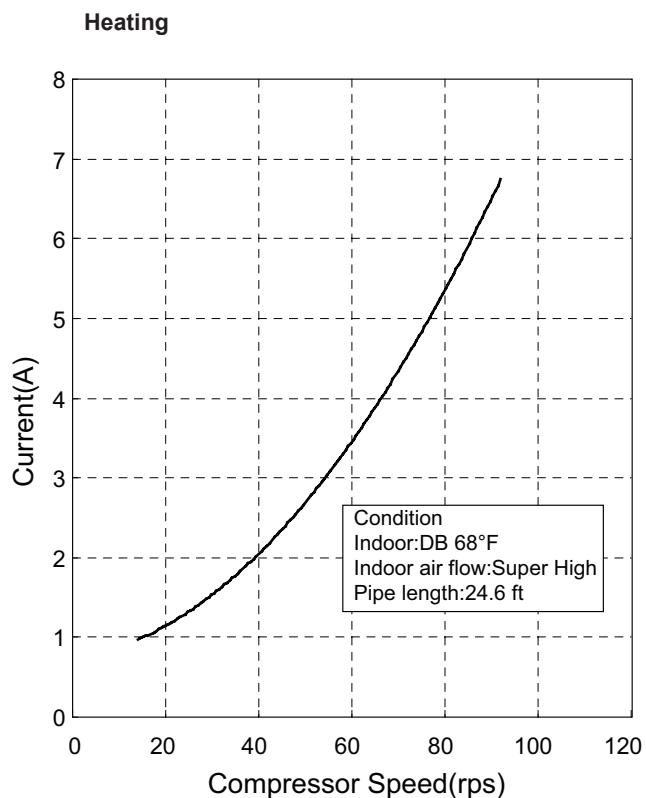
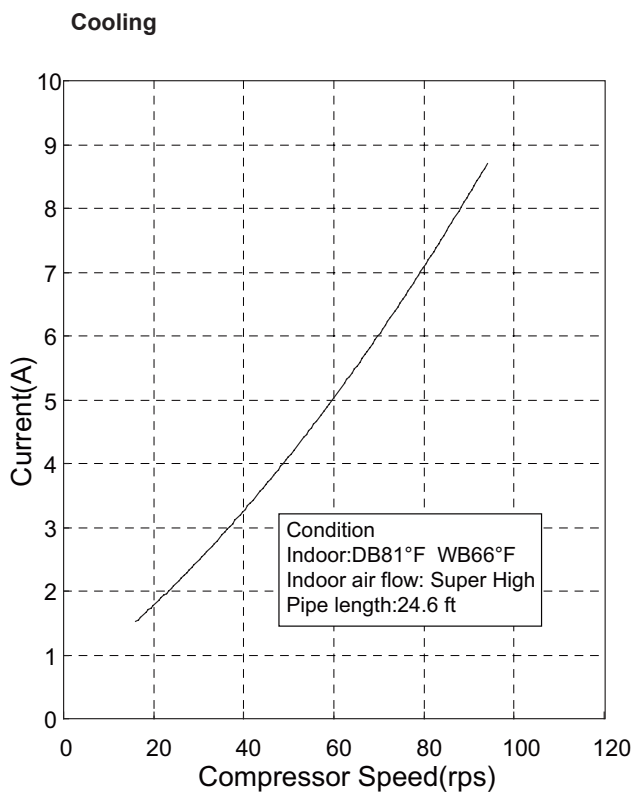

2.3 Capacity Variation Ratio According to Temperature

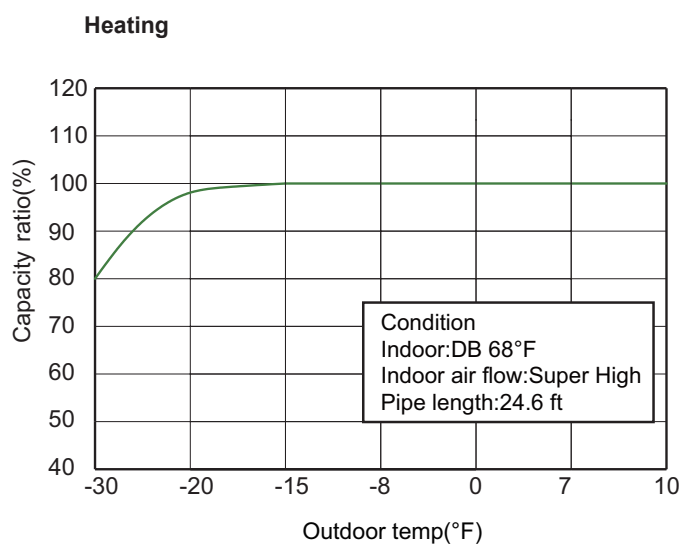
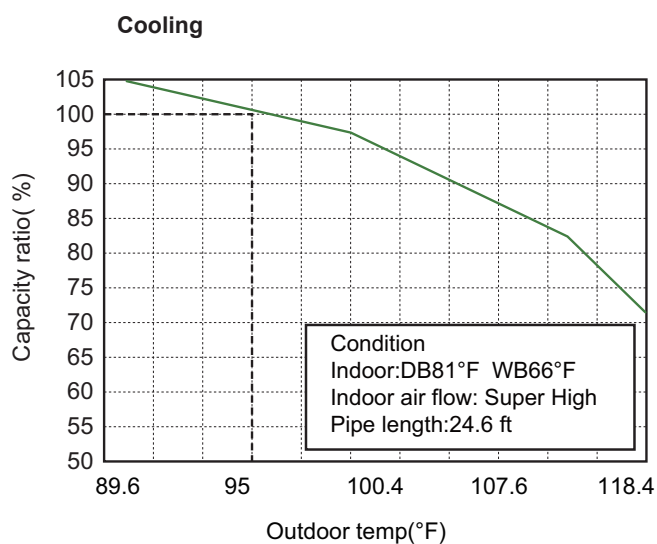

2.4 Cooling and Heating Data Sheet in Rated Frequency

Cooling:

Rated cooling condition(°F) (DB/WB)		Model	Pressure of gas pipe connecting indoor and outdoor unit	Inlet and outlet pipe temperature of heat exchanger		Fan speed of indoor unit	Fan speed of outdoor unit	Compressor revolution (Hz)
Indoor	Outdoor			T1 (°F)	T2 (°F)			
81/66	95/75	09/12K	123.2~145	in:46~52 out:52~57	in:122~176 out:99~109	Suprt High	High	58

Heating:

Rated heating condition(°F) (DB/WB)		Model	Pressure of gas pipe connecting indoor and outdoor unit	Inlet and outlet pipe temperature of heat exchanger		Fan speed of indoor unit	Fan speed of outdoor unit	Compressor revolution (Hz)
Indoor	Outdoor			T1 (°F)	T2 (°F)			
68/-	45/43	09/12K	362.3~435	in:122~176 out:99~109	in:34~37 out:36~41	Super High	High	56

Instruction:

T1: Inlet and outlet pipe temperature of evaporator

T2: Inlet and outlet pipe temperature of condenser

P: Pressure at the side of big valve

Connection pipe length: 24.6ft.

2.5 Noise Curve

Indoor side noise

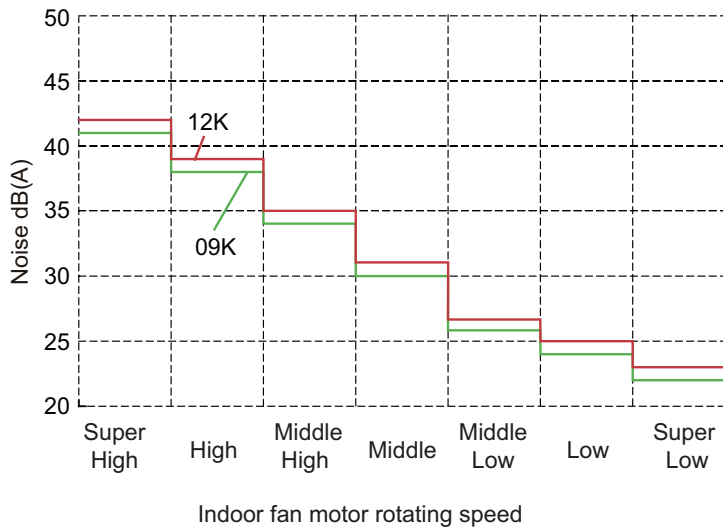

Outdoor side noise

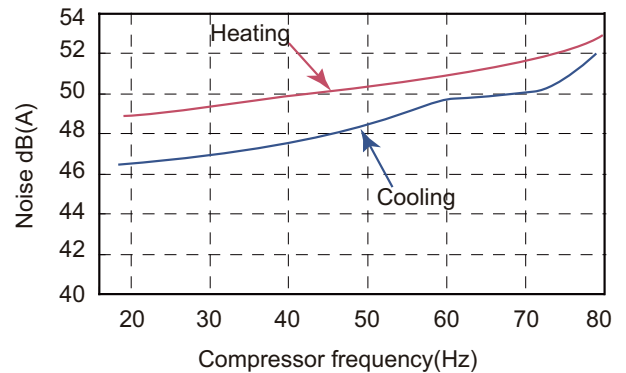

3. Outline Dimension Diagram

3.1 Indoor Unit

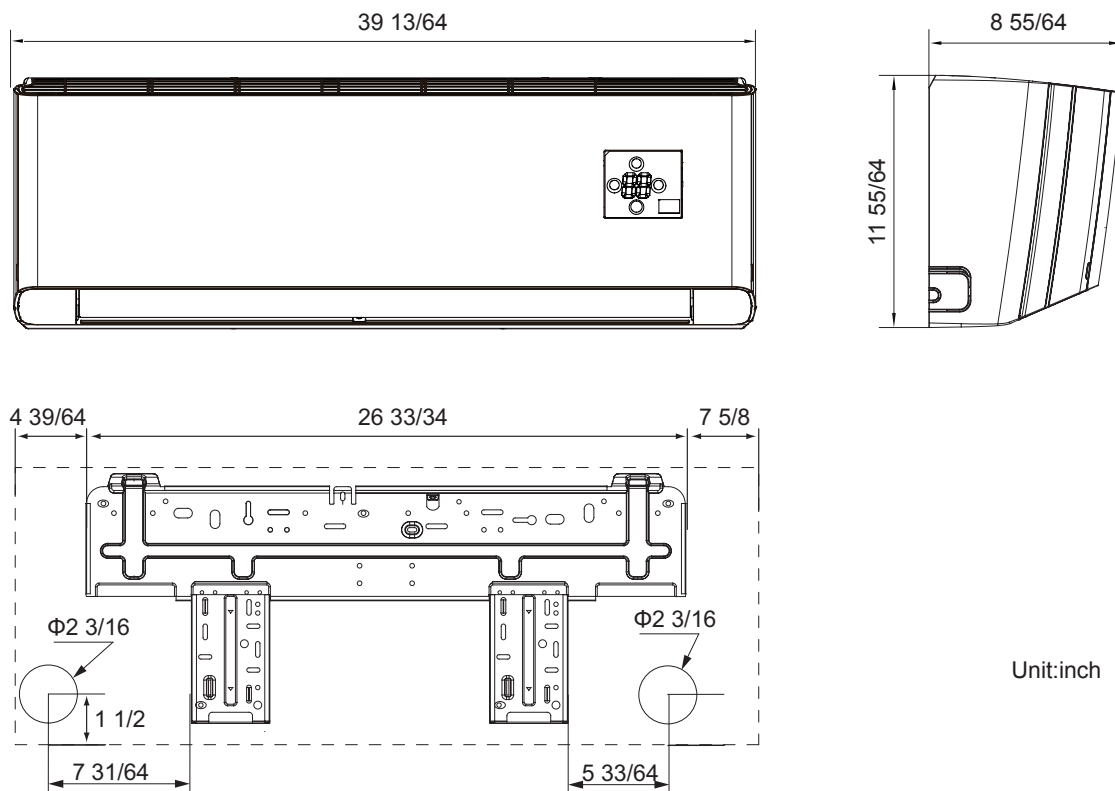

Unit:inch

4. Refrigerant System Diagram

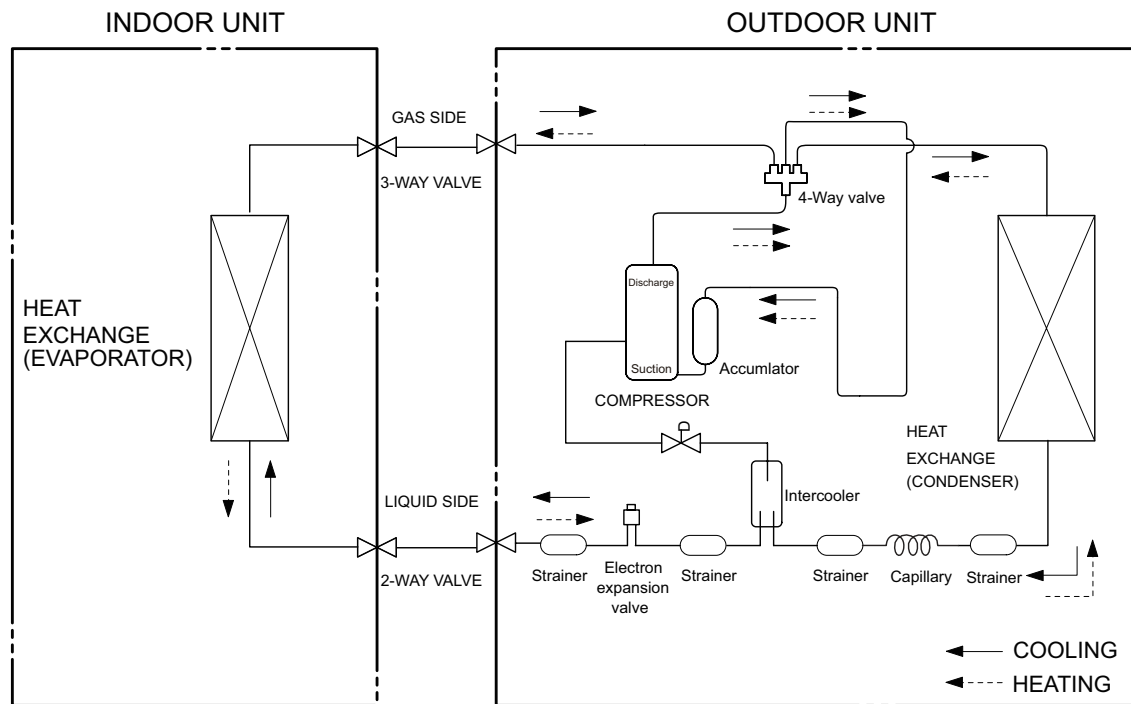

Connection pipe specification:

Liquid : 1/4

Gas : 1/2

5. Electrical Part

5.1 Wiring Diagram

● Instruction

Symbol	Symbol Color	Symbol	Symbol Color	Symbol	Name
WH	White	GN	Green	CAP	Jumper cap
YE	Yellow	BN	Brown	COMP	Compressor
RD	Red	BU	Blue	⊕	Grounding wire
YEGN	Yellow/Green	BK	Black	/	/
VT	Violet	OG	Orange	/	/

Note: Jumper cap is used to determine fan speed and the swing angle of horizontal lover for this model.

● Indoor Unit

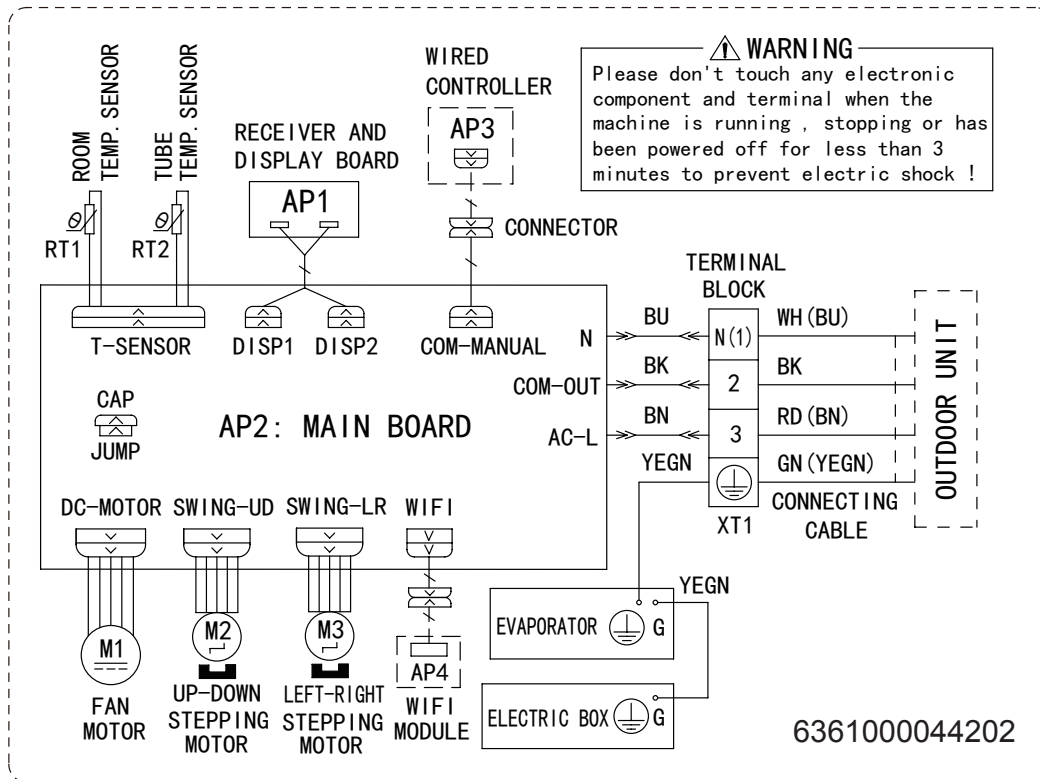

5.2 PCB Printed Diagram

Indoor Unit

• Top view

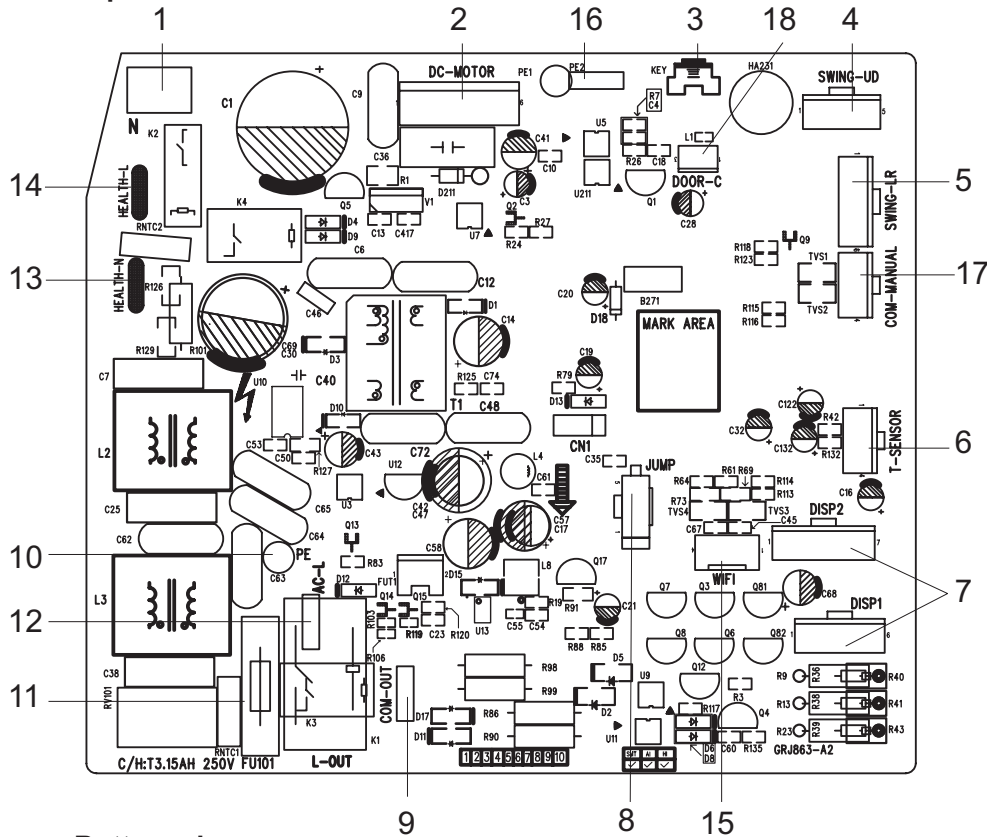

No.	Name
1	Neutral wire
2	Needle stand for indoor fan
3	Auto button
4	Up&down swing motor
5	left&right swing motor
6	Interface of temperature sensor
7	Terminal for display board connection
8	Terminal of jumper cap
9	Communication wire
10	Connect earthing wire(only for the mode with this function)
11	Fuse
12	Live wire interface
13	Interface of health function neutral wire
14	Interface of health function live wire
15	Detecting plate(WIFI)
16	Connect earthing wire(only for the mode with this function)
17	Wired controller (only for the mode with this function)
18	Interface of gate control (only for the mode with this function)

• Bottom view

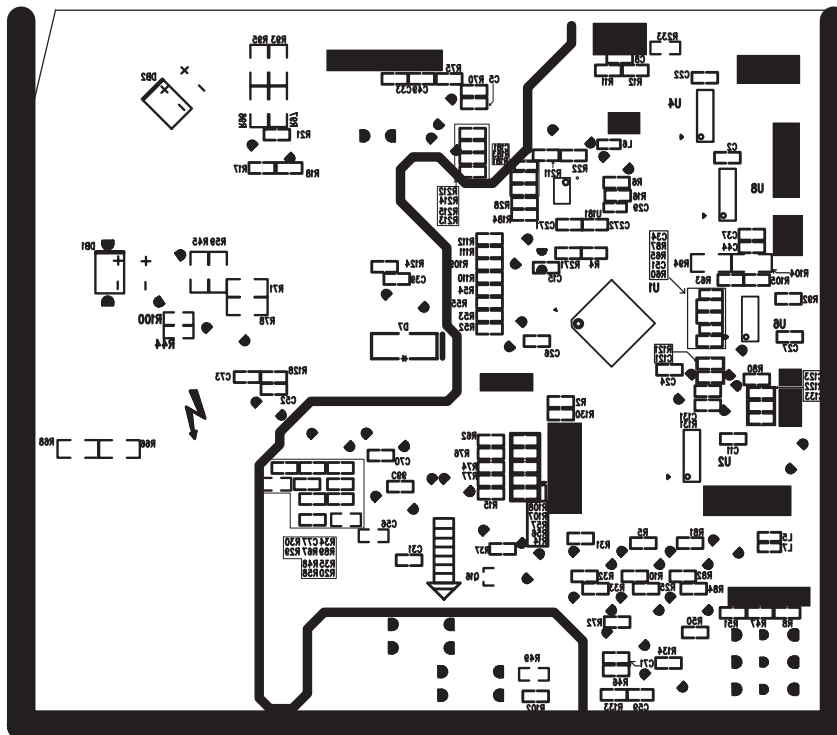

6. Function and Control

6.1 Remote Controller Introduction

Buttons on Remote Controller

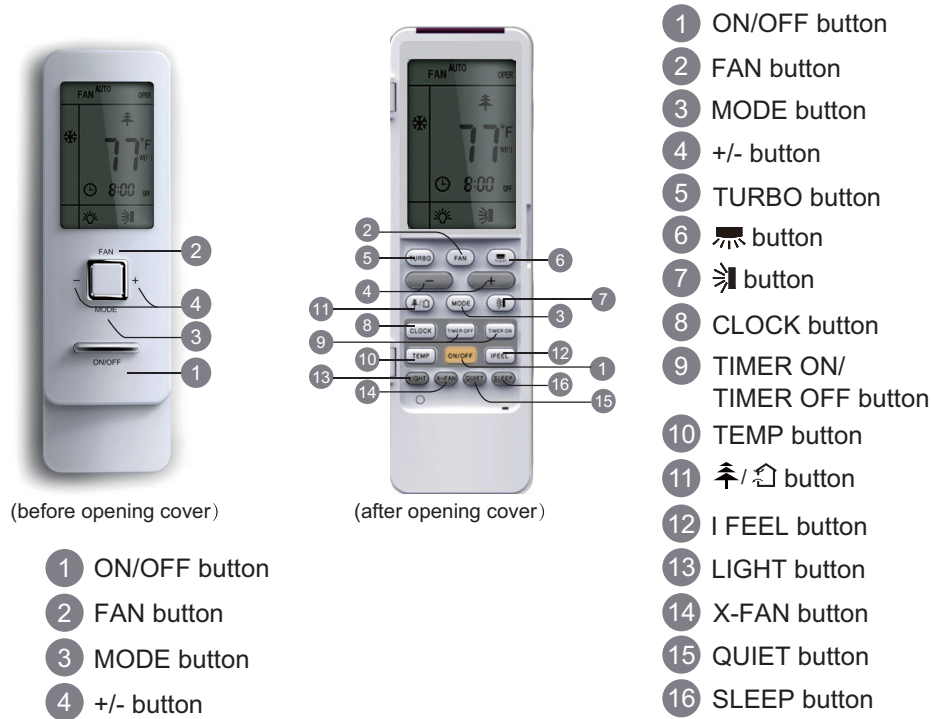

Introduction for Icons on Display Screen

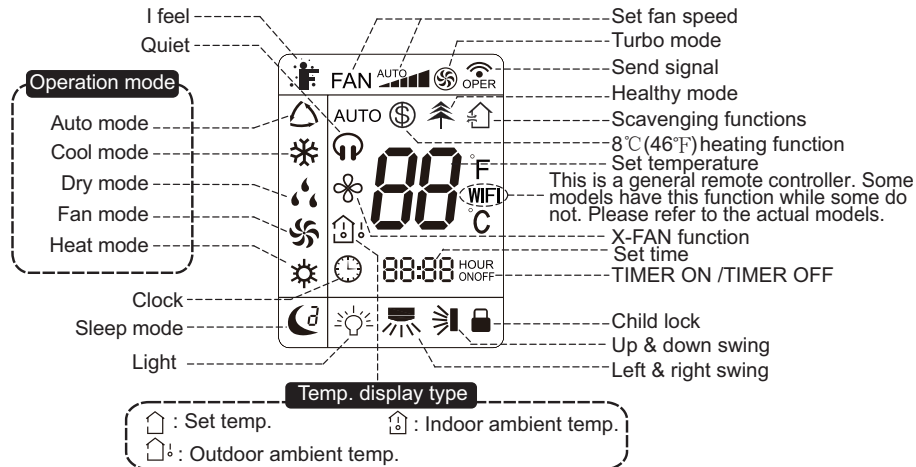

Introduction for Buttons on Remote Controller

Note:

- This is a general use remote controller, it could be used for the air conditioners with multifunction; For some function, which the model don't have, if press the corresponding button on the remote controller that the unit will keep the original running status.
- After putting through the power, the air conditioner will give out a sound. Operation indicator "🔌" is ON (red indicator). After that, you can operate the air conditioner by using remote controller.
- Under on status, pressing the button on the remote controller, the signal icon "📶" on the display of remote controller will blink once and the air conditioner will give out a "de" sound, which means the signal has been sent to the air conditioner.
- Under off status, set temperature and clock icon will be displayed on the display of remote controller (If timer on, timer off and light functions are set, the corresponding icons will be displayed on the display of remote controller at the same time); Under on status, the display will show the corresponding set function icons.

1. ON/OFF button

Press this button, the unit will be turned on, press it once more, the unit will be turned off. Sleep function will be canceled, while unit off.

2. FAN button

Press this button, Auto, Low, Medium-low, Medium, Medium-high, High speed can be circularly selected. After powered on, Auto fan speed is default. Under DRY mode, Low fan speed only can be set up.



Note: It's Low fan speed under Dry mode.

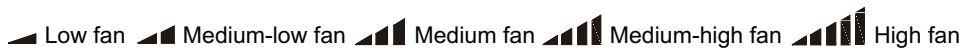

3. MODE button

Press this button, Auto, Cool, Dry, Fan, Heat mode can be selected circularly. Auto mode is default while power on. Under Auto mode, the temperature will not be displayed; Under Heat mode, the initial value is 28°C(82°F); Under other modes, the initial value is 25°C(77°F).

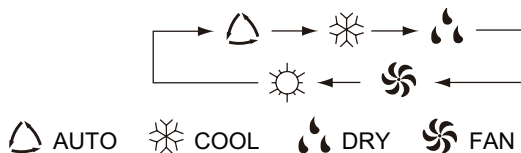

(only for cooling and heating unit. As for cooling only unit, it won't have any action when it receives the signal of heating operation.)

4. +/- button

- Presetting temperature can be increased. Press this button, the temperature can be set up, continuously press this button and hold for two seconds, the relative contents can quickly change, until unhold this button and send the order that the °C(°F) signal will be displayed all the time. The temperature adjustment is unavailable under the Auto mode, but the order can be sent by if pressing this button. Temperature of Celsius degree setting: 16-30; for Fahrenheit degree setting: 61-86.
- Presetting temperature can be decreased. Press this button, the temperature can be set up, continuously press this button and hold for two seconds, the relative contents can quickly change, until unhold this button and send the order that the °C(°F) signal will be displayed all the time. The temperature adjustment is unavailable under the Auto mode, but the order can be sent by if pressing this button.

5. TURBO button

Under Cool or Heat mode, press this button can turn on or turn off the Turbo function. After the Turbo function turned on, the signal of Turbo will display. The signal will be automatically cancelled if changing the mode or fan speed.

6. Swing button (This function is only available for some models)

Press this button to set left & right swing angle cycling as below:

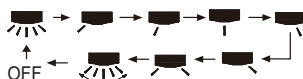

7. Guide Louver button

Press this button to set swing angle, which circularly changes as below:



This remote controller is universal. If it receives three kinds of following status, the swing angle will remain original.



If guide louver is stopped when it is swinging up and down, it will remain its present position.

☞ indicates guide louver swings back and forth in the five places, as shown in the figure.

8. CLOCK button

Press this button, the clock can be set up, signal 🕒 blink and display. Within 5 seconds, the value can be adjusted by pressing + or - button, if continuously press this button for 2 seconds above, in every 0.5 seconds, the value on ten place of Minute will be increased 1. During blinking, repress the Clock button or Confirm button, signal 🕒 will be constantly displayed and it denotes the setting succeeded. After powered on, 12:00 is defaulted to display and signal 🕒 will be displayed. If there is signal 🕒 be displayed that denotes the current time value is Clock value, otherwise is Timer value.

9. TIMER ON/TIMER OFF button

- Timer On setting: Signal "ON" will blink and display, signal 🕒 will conceal, the numerical section will become the timer on setting status. During 5 seconds blink, by pressing + or - button to adjust the time value of numerical section, every press of that button, the value will be increased or decreased 1 minute. Hold pressing + or - button, 2 seconds later, it quickly change, the way of change is: During the initial 2.5 seconds, ten numbers change in the one place of minute, then the one place is constant, ten numbers change in the ten splace of minute at 2.5 seconds speed and carry. During 5s blink, press the Timer button, the timer setting succeeds. The Timer On has been set up, repress the timer button, the Timer On will be canceled. Before setting the Timer, please adjust the Clock to the current actual time.
- One press this key to enter into TIMER OFF setup, in which case the TIMER OFF icon will blink. The method of setting is the same as for

●Sleep 3- the sleep curve setting under Sleep mode by DIY:

(1) Under Sleep 3 mode, press "Turbo" button for a long time, remote control enters into user individuation sleep setting status, at this time, the time of remote control will display "1hour ", the setting temperature "88" will display the corresponding temperature of last setting sleep curve and blink (The first entering will display according to the initial curve setting value of original factory);

(2) Adjust "+" and "-" button, could change the corresponding setting temperature, after adjusted, press "Turbo" button for confirmation;

(3) At this time, 1hour will be automatically increased at the timer position on the remote control, (that are "2hours" or "3hours" or "8hours "), the place of setting temperature "88" will display the corresponding temperature of last setting sleep curve and blink;

(4) Repeat the above step (2)(3) operation, until 8hours temperature setting finished, sleep curve setting finished, at this time, the remote control will resume the original timer display;temperature display will resume to original setting temperature.

●Sleep3- the sleep curve setting under Sleep mode by DIY could be inquired:

The user could accord to sleep curve setting method to inquire the presetting sleep curve, enter into user individuation sleep setting status, but do not change the temperature, press "Turbo" button directly for confirmation.

Note: In the above presetting or enquiry procedure, if continuously within 10s, there is no button pressed, the sleep curve setting status will be automatically quit and resume to display the original displaying. In the presetting or enquiry procedure, press "ON/OFF" button, "Mode" button, "Timer" button or "Sleep" button, the sleep curve setting or enquiry status will quit similarly.

17. About X-FAN function

This function indicates that moisture on evaporator of indoor unit will be blown after the unit is stopped to avoid mould.

(1)Having set X-FAN function on: After turning off the unit by pressing ON/OFF button indoor fan will continue running for about 2 min. at low speed. In this period, press X-FAN button to stop indoor fan directly.

(2)Having set X-FAN function off: After turning off the unit by pressing ON/OFF button, the complete unit will be off directly.

18. About AUTO RUN

When AUTO RUN mode is selected, the setting temperature will not be displayed on the LCD, the unit will be in accordance with the room temp. automatically to select the suitable running method and to make ambient comfortable.

19. About turbo function



If start this function, the unit will run at super-high fan speed to cool or heat quickly so that the ambient temp. approaches the preset temp. as soon as possible.

20. About lock

Press + and - buttons simultaneously to lock or unlock the keyboard. If the remote controller is locked, the icon  will be displayed on it, in which case, press any button, the mark will flicker for three times. If the keyboard is unlocked, the mark will disappear.



21. About swing up and down

(1)Press swing up and down button continuously more than 2s,the main unit will swing back and forth from up to down, and then loosen the button, the unit will stop swinging and present position of guide louver will be kept immediately.

(2)Under swing up and down mode, when the status is switched from off to , if press this button again 2s later,  status will switch to off status directly; if press this button again within 2s,the change of swing status will also depend on the circulation sequence stated above.

22. About swing left and right(This function is only available for some models)

(1)Press swing left and right button continuously more than 2s,the main unit will swing back and forth from left to right, and then loosen the button, the unit will stop swinging and present position of guide louver will be kept immediately.

(2)2. Under swing left and right mode, when the status is switched from off to , if press this button again 2s later,  status will switch to off status directly; if press this button again within 2s,the change of swing status will also depend on the circulation sequence stated above.

23. About switch between Fahrenheit and Centigrade

Under status of unit off, press MODE and - buttons simultaneously to switch °C and °F.

24. Combination of "TEMP" and "CLOCK" buttons : About Energy-saving Function

Press "TEMP" and "CLOCK" simultaneously in COOL mode to start energy-saving function.Nixie tube on the remote controller displays "SE".

Repeat the operation to quit the function.

25. Combination of "TEMP" and "CLOCK" buttons : About 8°C(46°F) Heating Function(This function is only available for some models)

Press "TEMP" and "CLOCK" simultaneously in HEAT mode to start 8°C(46°F)Heating Function.Nixie tube on the remote controller displays "" and a selected temperature of "8°C" (46°F if Fahrenheit is adopted). Repeat the operation to quit the function.

26. About Auto Quiet function

When auto quiet function is selected:

(1)Under cooling mode: indoor fan operates at notch 4 speed. 10 minutes later or when indoor ambient temperature ≤28°C(82°F), indoor fan will operate at notch 2 speed or quiet mode according to the comparison between indoor ambient temperature and set temperature.

(2)Under heating mode: indoor fan operates at notch 3 speed or quiet mode according to the comparison between indoor ambient temperature and set temperature.

(3)Under dry, fan mode: indoor fan operates at quiet mode.

(4)Under auto mode: the indoor fan operates at the auto quiet mode according to actual cooling, heating or fan mode.

27. About Sleep function

Under the Fan and Auto mode, the Sleep function cannot be set up, under Dehumidify mode, only Sleep 1 can be selected.Select and enter into any kind of Sleep mode, the Quiet function will be attached and started, different Quiet status could be optional and turned off.

28. WIFI Fuction (This unit is without WiFi fuction)



Press "MODE" and "TURBO" button simultaneously to turn on or turn off WIFI function. When WIFI function is turned on, the "WiFi" icon will be displayed on remote controller; Long press "MODE" and "TURBO" buttons simultaneously for 10s, remote controller will send WIFI reset

code and then the WIFI function will be turned on. WiFi function is defaulted ON after energization of the remote controller.

- This function is only available for some models.

Operation Guide

1. General operation

- (1)After powered on, press ON/OFF button, the unit will start to run. (Note: When it is powered on, the guide louver of main unit will close automatically.)
- (2)Press MODE button, select desired running mode.
- (3)Pressing + or - button, to set the desired temperature (It is unnecessary to set the temp. at AUTO mode.)
- (4)Pressing FAN button, set fan speed, can select AUTO FAN,LOW, MEDIUM-LOW, MEDIUM, MEDIUM-HIGH and HIGH.
- (5)Pressing  and  button, to select the swing.

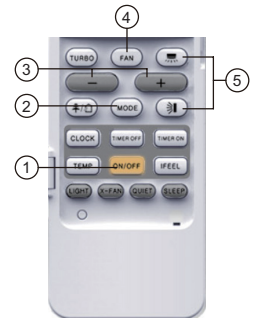

2. Optional operation

- (1)Press SLEEP button, to set sleep.
- (2)Press TIMER ON and TIMER OFF button, can set the scheduled timer on or timer off.
- (3)Press LIGHT button, to control the on and off of the displaying part of the unit (This function may be not available for some units).
- (4)Press TURBO button, can realize the ON and OFF of TURBO function.

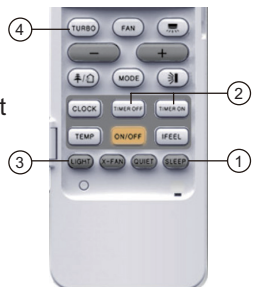

Replacement of Batteries in Remote Controller

1. Press the back side of remote controller marked with , as shown in the fig, and then push out the cover of battery box along the arrow direction.
2. Replace two 7# (AAA 1.5V) dry batteries, and make sure the position of "+" polar and "-" polar are correct.
3. Reinstall the cover of battery box.

Note:

- During operation, point the remote control signal sender at the receiving window on indoor unit.
- The distance between signal sender and receiving window should be no more than 8m, and there should be no obstacles between them.
- Signal may be interfered easily in the room where there is fluorescent lamp or wireless telephone; remote controller should be close to indoor unit during operation.
- Replace new batteries of the same model when replacement is required.
- When you don't use remote controller for a long time, please take out the batteries.
- If the display on remote controller is fuzzy or there's no display, please replace batteries.

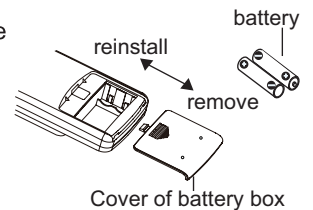

6.2 Operation of Smart Control (Smart Phone, Tablet PC) For Gree

Operation Instructions

Download and install APP

Scan the following QR code with your smart phone and download Wifi Smart.



Install the APP according to its guidance. When successfully installed, your smart phone homepage will show this icon . User of IOS system can search for the Gree Smart in Apple store to download the Apple version APP.

Configuration

NOTE: Select either the original configuration or AP configuration according to the APP functions.

1.Original configuration

Before operation, please finish the following configuration in order to realize Wifi control and the connection between air conditioner and intelligent device.

(1).Short-distance control setting for air conditioner using Wifi hotspot

Step 1: Air conditioner Wifi is set in AP mode in factory. You can search the air conditioner Wifi hotspot through your smart phone. The name of Wifi hotspot is the last 8 numbers of the air conditioner mac address. Password is 12345678.

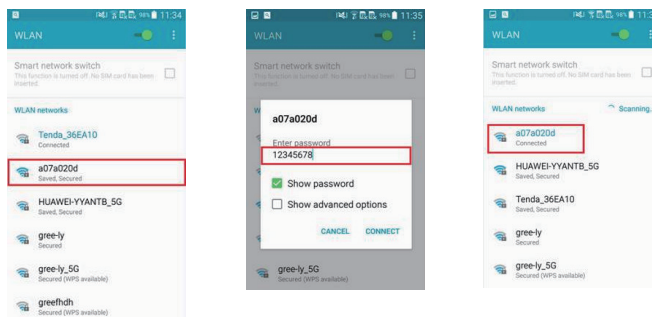

Step 2: Open APP and the screen will show the air conditioner that you just connected. Tap the name of this air conditioner on your phone to enter and realize short-distance control, as shown below. Please refer to "Functions introduction" for specific control methods.

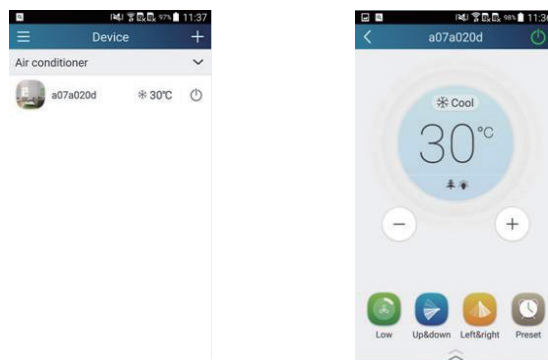

NOTE:One AC can be controlled by 4 smart phones in maximum at the same time.

(2).Short-distance and long-distance control setting for air conditioner connecting with router

Step 1: Under short-distance control, return to the homepage "Home Control". Tap  at the top right corner of the homepage "Device".

Select "Add device" and enter the page of "Add device". Tap "Manual configuration" and enter the page "Manual configuration".
 Step 2: Select the correct network name and enter the password. Select the server (The server setting here must keep the same as the server setting in "Settings" mentioned below. Otherwise, remote control will fail.), then tap the button "Add device" for configuration. At this time, "Configuring" is displayed on the APP. The buzzer in the indoor unit will give out a sound when configuration succeeds.

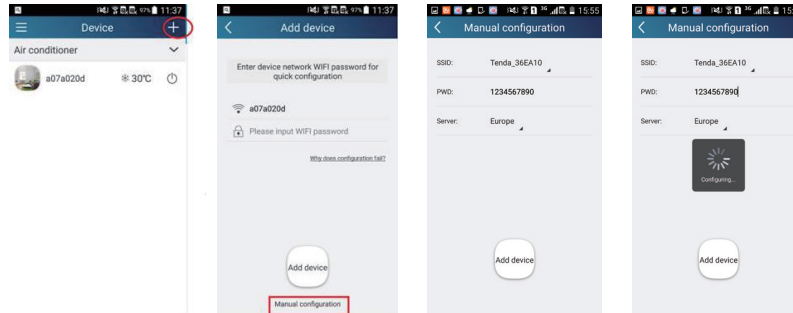

2.AP configuration

4 steps of configuration

Step 1: Enter homepage "Device", and then tap **+** at the top right corner. Select "Add device" and enter the page "Add device". Tap "Manual Configuration".

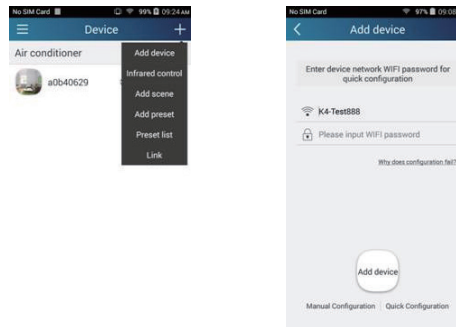

Step 2: Tap "Next" in the First Step.

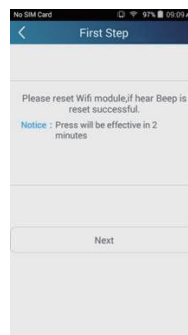

Step 3: Select the wireless network of air conditioner. APP will show the password 12345678 (default password of the network of air conditioner). Then tap "Next"; select the name of home Wifi router, then enter the correct password and select a server.

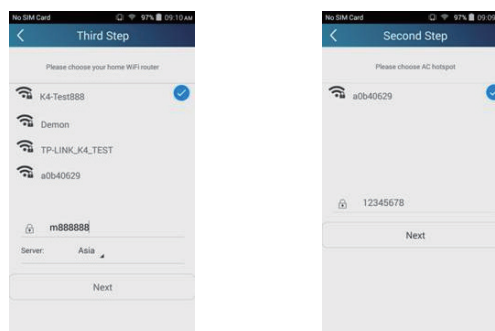

Step 4: If configuration is successful, a window will pop up and read "Configuration succeeded". Then configuration is completed.

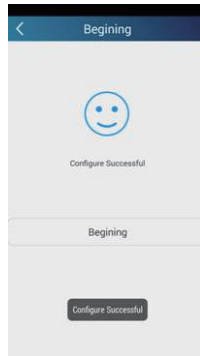

NOTE: After configuration is completed, the air conditioner hot spot connected to your phone will disappear. You should reconnect your phone to the home Wifi router to realize long-distance control.

The above configuration only needs one phone. Other types of phones shall install this APP, connect with the air conditioner hot spot or wireless router of Wifi air conditioner. When connection is done, open the APP to use short-distance operation to control the air conditioner and then you can use the long-distance control.

Functions introduction

1. User registration

Purpose: To realize long-distance control

Operation instruction: For the first time login, you have to register a new username. If you already have a username, skip the registration step and enter email address and password on the "Login Page" to log in. If password is forgotten, you can reset the password.

Operation steps:

(1) Select the sever address

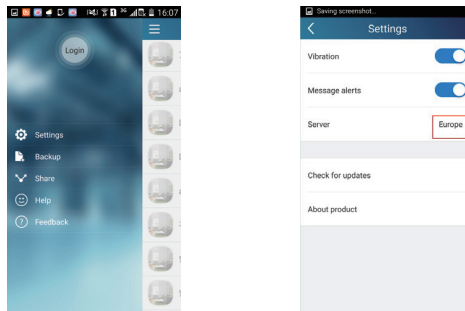

(2) Account login: Slide the page "Device", and enter the page "Menu" on the left. Tap "Login" to enter the page "Register username". New user must first register a username. Tap "Register".

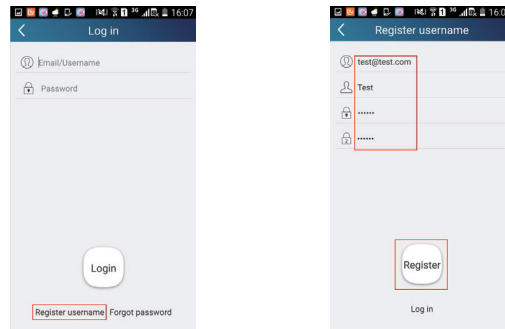

(3) Enter your email address. Wait until you receive the verification code. Enter the code and then tap "OK" to log in.

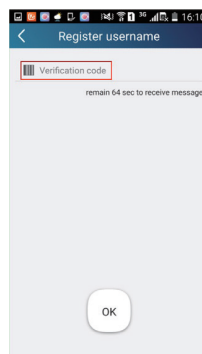

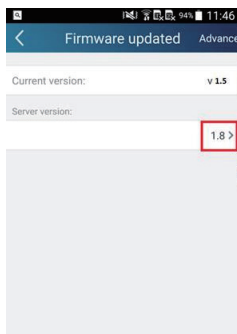

(2) Set preset name

Step 1: Tap  at the top right corner of the homepage "Device". Select "Add preset" and enter the page "Preset edit".

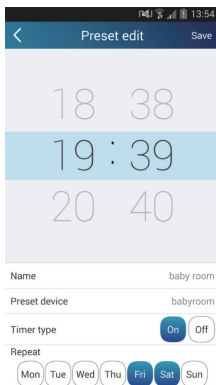

Step 2: Choose the time. Tap "Name". As shown in the picture, its name is "baby room". For timer type, select "On". Then select the repeating days. Save the setting of preset name.

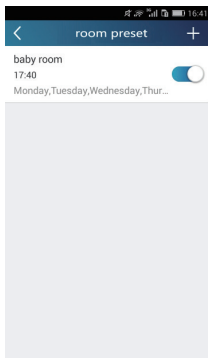

(3) Set device image

Please refer to step 1 in 2(1)

3. Control functions

(1) Common control functions: General control on the operation of smart devices (On/Off, temperature, fan speed, mode, etc.) and the setting of advanced functions (air exchange, dry, health, light, sleep, energy saving upper limit).

Step 1: General control

Enter the homepage "Home control" first. Take "babyroom" as an example.

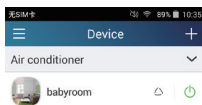

Tap "babyroom" and enter the page of air conditioner control. Tap  to turn on the control switch.

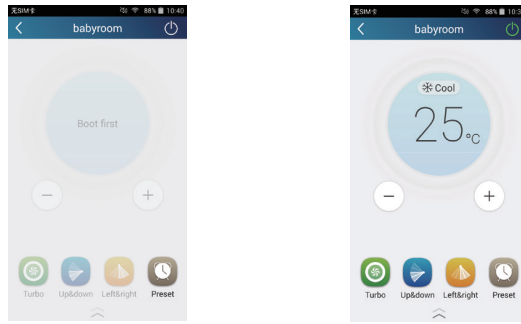

Tap or to increase or decrease temperature. Tap to change working mode. Tap



to enter the page of fan speed adjustment.

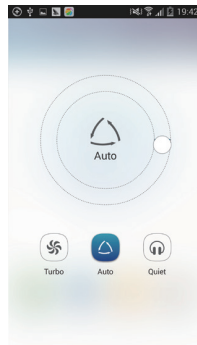

Tap and go around the circle to adjust fan speed.

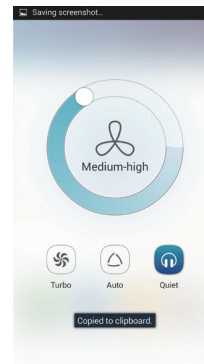
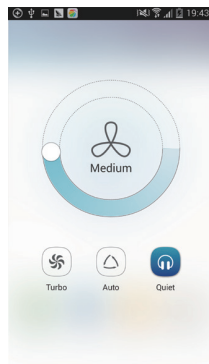

Step 2: Advanced settings

Tap to enter advanced settings. You may select "Air", "Dry", "Health", "Light", "Sleep" or "Energy saving".

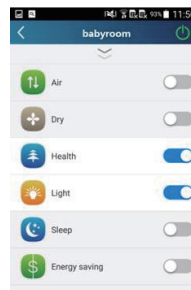
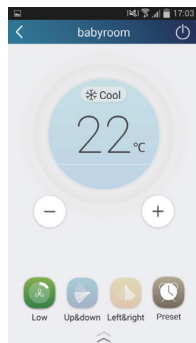

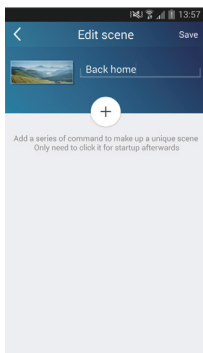

(2) Advanced control functions: Set scene; Preset; Link; Infrared control (only APPLICABLE to smart phones with infrared emitter)
 Set scene: Preset the operation of several smart devices by one tap.
 On the page "Home control", tap the image of "Home control" to enter the page "Edit scene".

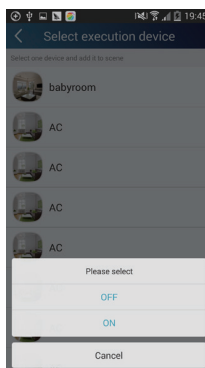
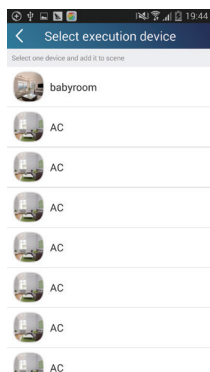

Tap "Add scene" and edit the scene name, for example, "Back home". Add execution devices.

Tap  to add commands. On the page "Select execution device", select the air conditioner named "babyroom". Then select "ON" or "OFF".



Continue to select the next execution device as instructed above. Tap  to set the interval.

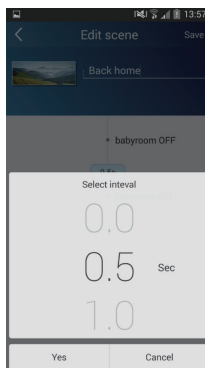
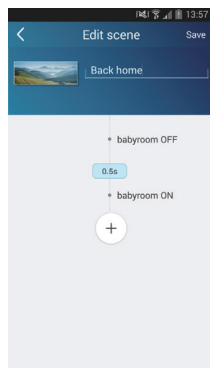

Tap "Save". Tap the scene picture displayed on homepage "Device" to send the command. Then the scene "Back home" will be in execution. You may view the execution condition of the scene.

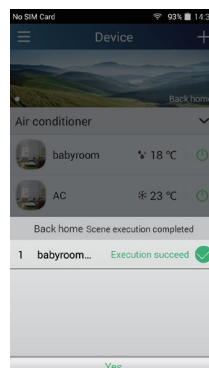
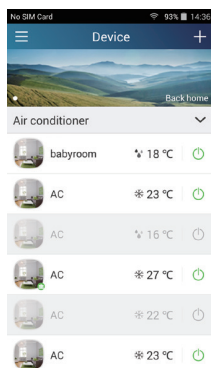

(3) Preset includes single-device preset and multi-device preset

Single-device preset: This can preset a certain device to be On/Off at a specific time.

On the homepage "Device", take air conditioner "babyroom" as an example. Tap  at the bottom of the page "babyroom". Then you will enter the page "Preset edit".

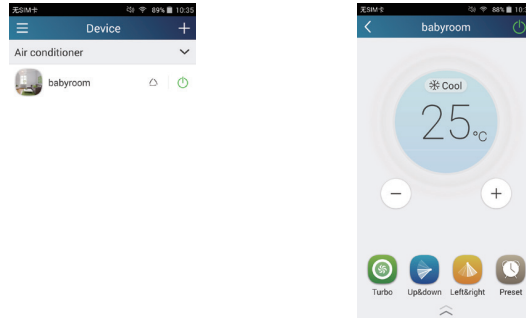

Slide up and down to set the time. If you need to synchronize the time, tap "synchronize". If such "Hint" interface doesn't show up, please skip this operation step.

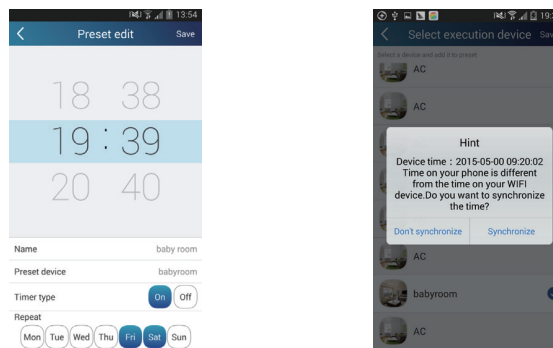

Tap "Name" to customize the preset name.

Preset device can't be selected and it will default to "babyroom". Select "On" for the timer type. Select repeating days to complete the preset.

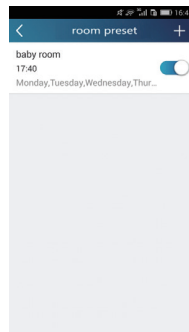

Multi-device preset: This can preset multiple devices to execute a command at a specific time.

Please refer to the instructions as how to set preset time, name, timer type and repeating days for a single device.

Tap "Preset device" to select one or more devices. Then return to the page "Device".

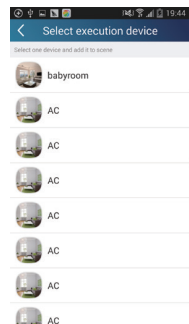

(4) Link(This function is APPLICable to some models)

Select a master device. When the environment satisfies the parameters as set in the master device, slave devices will execute commands to realize devices linkage.

Step 1: Set the parameters of master device (Select master device, select environment parameters, select master device status).

Tap **+** at the top right corner of the homepage "Device". Select "Link" and enter the page "Add linkage". Tap "Device/Param" to enter the page "Select device". Take "baby room" as an example. Tap "babyroom".

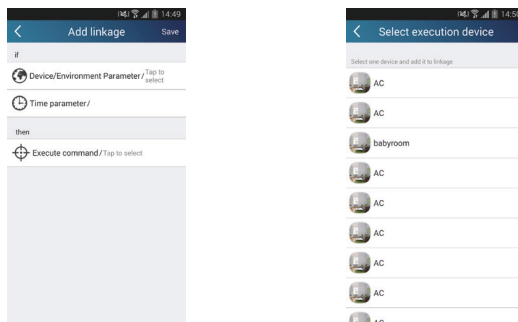

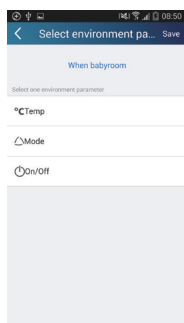

Enter the page "Select environment parameters".

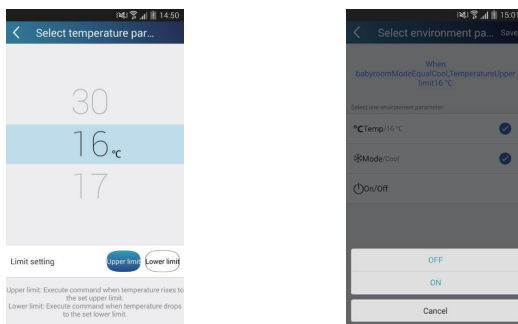

Tap "Temperature" to enter the page "Select temperature parameter". Slide up or down to adjust temperature. Tap "Upper limit" or "Lower limit".

Tap "Mode" and "On/Off" to select the status of master device. Then tap "Save".



Step 2: Set time parameter for linkage. Tap "Time parameter" to enter the page "Set time". Slide  towards to turn on the setting time.

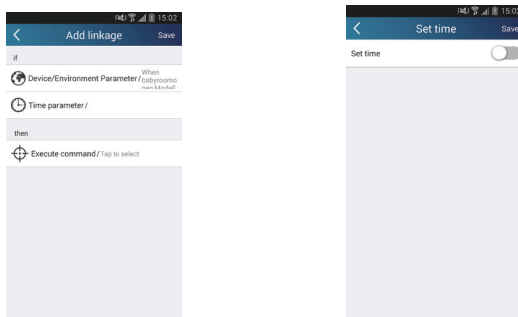

Tap "Execution time"; then tap "Start" and "Stop" to set start time and stop time respectively. Tap "OK" at the top right corner to save the setting.

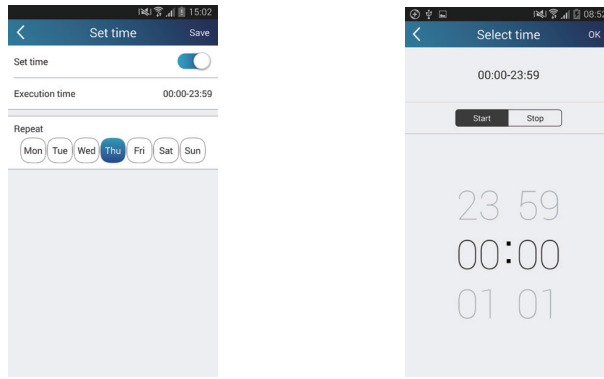

Tap the days below "Repeat" to select the repeating days. Then tap "Save".

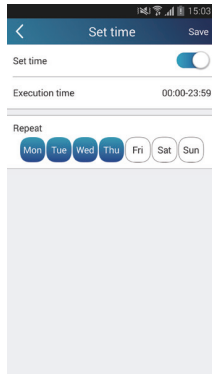

Step 3: Select "Execute command"
Tap "Execute command" and enter the page "Select device".

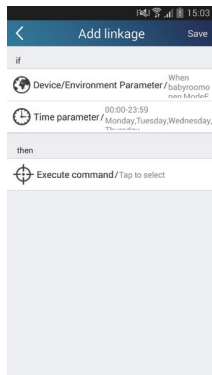

Tap the name of device that you want to control. Tap "ON" or "OFF" and then tap "Save" to complete the linkage.

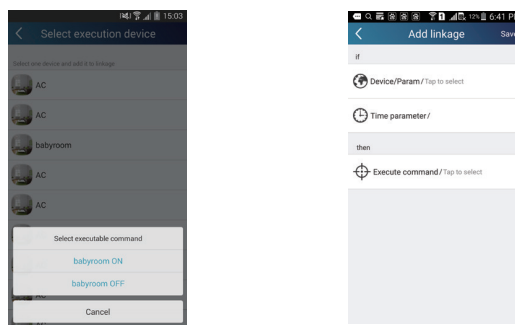

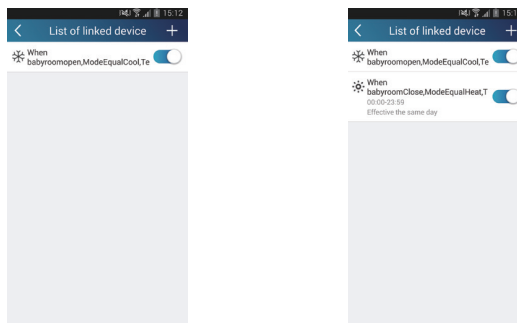

Tap "Save" and then repeat the above steps to set linkage of several scenes.



(5) Infrared control (only APPLICable to smart phones with infrared emitter).

Function: Smart phone can be used as a remote controller.

Tap  at the top right corner of the homepage "Device". Select "Infrared" and enter the page "Remote controller". Tap  and slide up to enter the page of advanced functions.



Tap  to turn on the device. Tap  to select mode. Tap  to adjust fan speed and swing angle. Tap "Health", "Energy saving", "Sleep" etc. to set advanced functions.

Tap "Sleep" to enter the page "Sleep". You can select "Traditional sleep", "Expert sleep" or "DIY sleep". Tap "DIY sleep" and then tap the left and right arrows to set sleep time. Tap up and down arrows to adjust temperature at a specific sleep time.

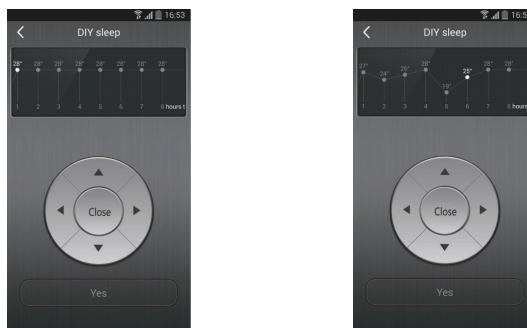

4.Menu functions

Menu functions (Share, Set, History, Feedback)

(1) Share: To share quick configuration information and unit's information, including local export and local import. For local import, you just need to tap "Local import" and wait for the data download.

Local export

Step 1: Export local data to another smart phone.

Enter "Menu" on the left side and tap "Share" to enter the page "Share". Then tap "Local export".

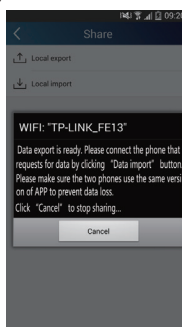

(3) Settings

User can set vibration, message alerts, server, updates, etc. The server setting here must be the same as the server setting in "Configuration" mentioned before.

Otherwise, remote control will be invalid.

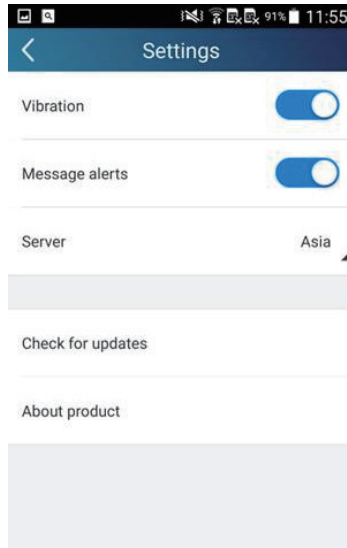

(4) Feedback

User can feedback suggestions to back-stage management for maintenance and development.

Tap "Feedback". Enter your suggestions and then submit it.

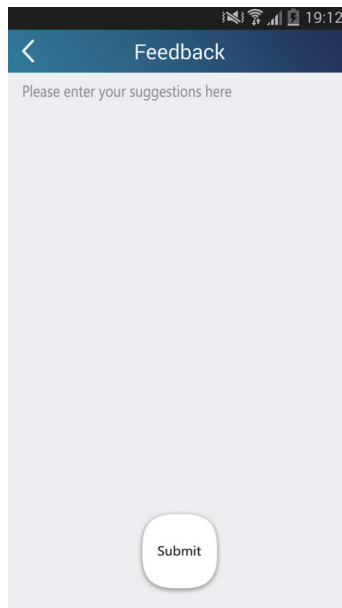

6.3 Operation of Smart Control (Smart Phone, Tablet PC)

Operation Instructions

Download and install APP

Scan the following QR code with your smart phone and download Wifi Smart.



Install the APP according to its guidance. When successfully installed, your smart phone homepage will show this icon 

User of IOS system can search for the Wifi Smart in Apple store to download the Apple version APP. Android user can search "WiFi Smart" on Google Play to download it.

Configuration

NOTE: Select either the original configuration or AP configuration according to the APP functions.

1. Original configuration

Before operation, please finish the following configuration in order to realize Wifi control and the connection between air conditioner and intelligent device.

(1). Short-distance control setting for air conditioner using wifi hotspot

Step 1: Air conditioner wifi is set in APP mode in factory.

You can search the air conditioner wifi hotspot through your smart phone. The name of wifi hotspot is the last 8 numbers of the air conditioner mac address. Password is 12345678.

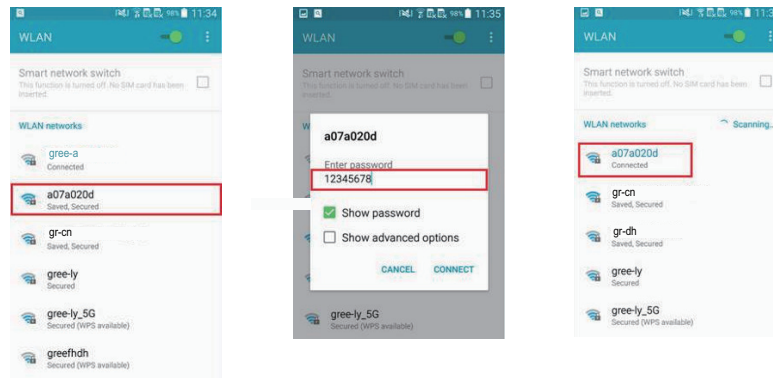

Step 2: Open APP and the screen will show the air conditioner that you just connected. Tap the name of this air conditioner on your phone to enter and realize short-distance control, as shown below. Please refer to "Functions introduction" for specific control methods.

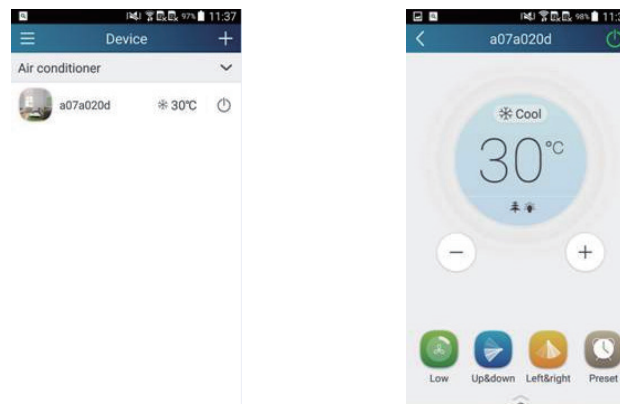

2.Configuration method for Android phones

4 steps of configuration

Step 1: Enter homepage "Device", and then tap **+** at the top right corner.

Select "Add device" and enter the page "Add device".

Tap "Manual configuration" and enter the page "Manual configuration".

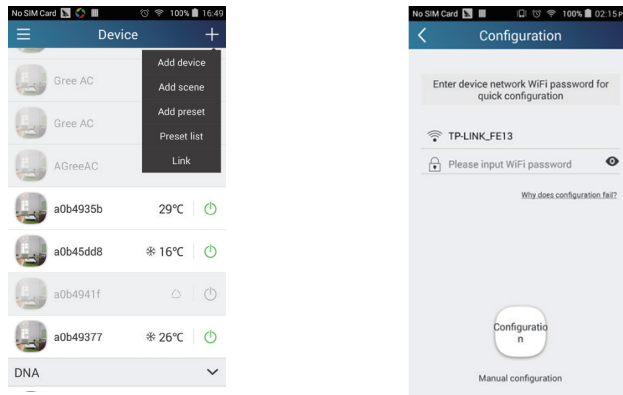

Step 2: Tap "Next" in the First Step.

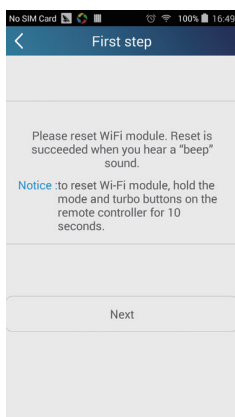

Step 3: Select the wireless network of air conditioner. APP will show the password 12345678 (default password of the network of air conditioner). Then tap "Next"; select the name of home WiFi router, then enter the correct password and select a server.

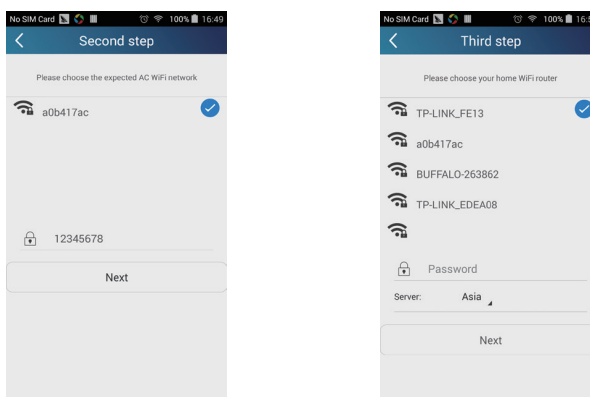

Step 4: If configuration is successful, a window will pop up and read "WiFi module starts to connect the configured wireless router".Then configuration is completed.

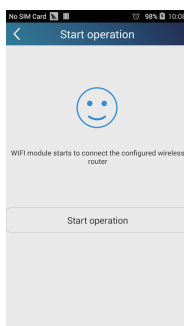

NOTE: After configuration is completed, the air conditioner hot spot connected to your phone will disappear. You should reconnect your phone to the home WiFi router to realize long-distance control. The above configuration only needs one phone. Other types of phones shall install this APP, connect with the air conditioner hot spot or wireless router of WiFi air conditioner. When connection is done, open the APP to use short-distance operation to control the air conditioner and then you can use the long-distance control.

3. Configuration method for Apple phones

Step 1: Turn on Wi-Fi “Settings” on the phone.

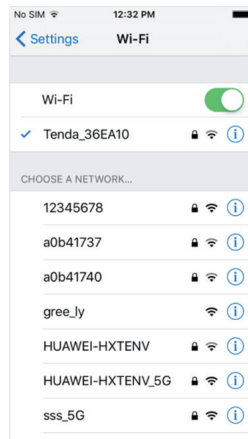

Step 2: In general, the hot spot signal of air conditioner is the last 8 bits of MAC address. Eg: Select “a0b41737” and enter the defaulted password “12345678” to connect it.

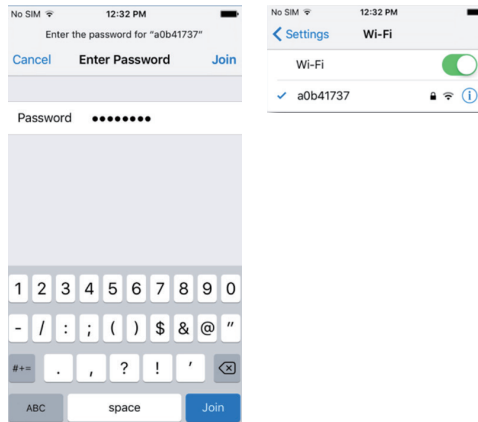

Step 3: Turn on APP, press “+” button, press “Add device” to enter into the page of “Add device” and then select “Manual configuration”. Enter wireless router’s SSID and PSW on the page of “Manual configuration”. The display on the server will be the same as the selection when registering the account (server selection in “Setting”).

Eg: WiFi name: Tenda_XXX;

WiFi password:123456789

Server: Europe

Check whether the filled information is correct. If the information is wrong, configuration will fail. Press “Configuration” to start configuration.

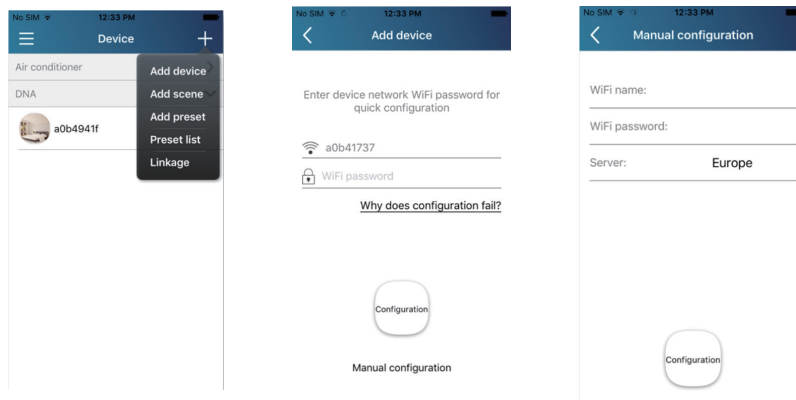

Notice:

- Finally, press “Configuration”, and APP will send the filled information to Wifi Smart. At this time, the buzzer will give out a sound, which indicates it has started to connect the wireless router.

- If the name of router or the password is wrong, Wifi Smart can't connect to the wireless router. 2 mins later, please conduct the configuration operation again. Reset Wi-Fi adaptor by pointing you remote at the indoor unit and holding the mode and Turbo buttons on your remote control for 10 seconds and until you hear the beep.
- Wrong server selection will cause long-distance control invalid. Therefore, please make sure that the server selection when registering the account is the same as this one.
- If the password is blank, no password is defaulted for the wireless router, which is the OPEN mode.
- Configuration should be conducted at one time. As for other phones, they can automatically search for the device after connecting to the wireless router (such as Tenda_XXX) and turning on the APP.

Functions introduction

1. User registration

Purpose: To realize long-distance control.

Operation instruction: For the first time login, you have to register a new username. If you already have a username, skip the registration step and enter email address and password on the "Login Page" to log in. If password is forgotten, you can reset the password.

Operation steps:

(1) Select the sever address.

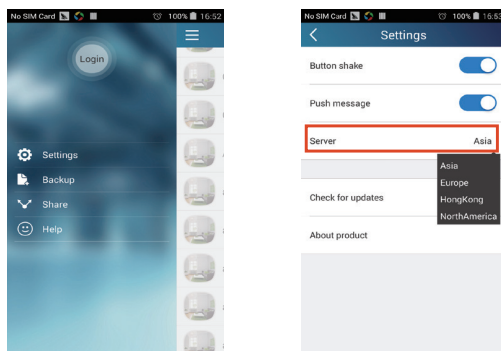

(2) Account login: Slide the page "Device", and enter the menu page on the left. Tap "Login" to enter the page "Register username". New user must first register a username. Tap "Register".

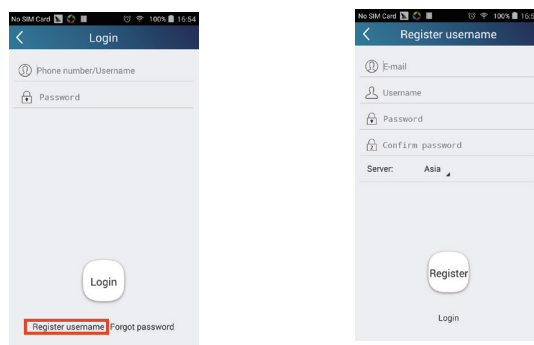

(3) If password is forgotten, you can reset the password with your email address.

Tap "Forgot password" and enter the page "Forgot password". Enter your registered email account the first. Tap "Get verification code" to get an email verification code. Enter a new password and tap "OK" to log in.

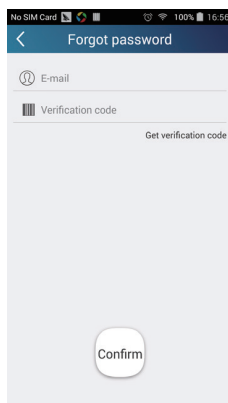

2. Personal settings

Purpose: Set name (device name, preset name, etc.) and images (device image) in order to identify a user easily.

(1) Set device name

After quick configuration, a list of controllable smart devices will be generated. Default name for air conditioner is the last 8 numbers of the air conditioner mac address.

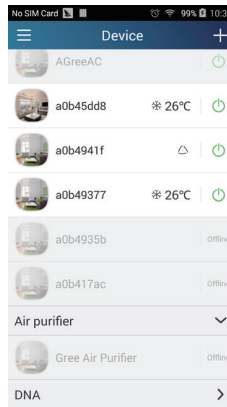

Step 1: Tap and hold the Wifi model name, such as "a0b417ac", to enter the page "Edit device". Tap "Image" to select the source of image. Select from "Default images " or " Take photo" or "Choose from photos" and save an image.

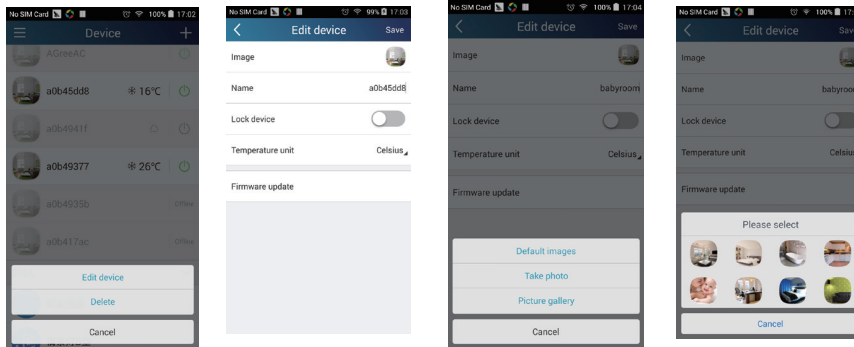

Step 2: Tap "Name" to change device name. Save it and the new device name will be shown. Enable button "Lock device" to lock the device so that other smart phones can't search the device. Tap "Temperature unit" to change the temperature unit.

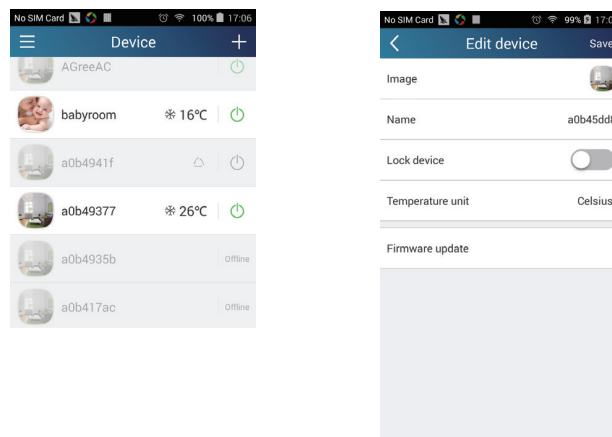

Notice: If this device is not locked, other phones within the local area network can be found through wifi smart APP and operate the device.

Step 3: Tap "Firmware update" to upgrade the firmware of the device. Tap"1.7" and then the device will be updated automatically.

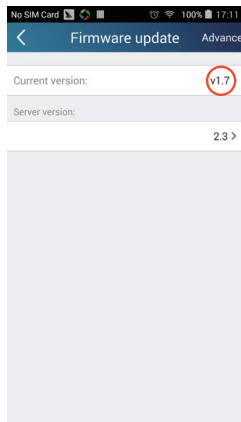

(2) Set preset name

Step 1: Tap  at the top right corner of the homepage "Device". Select "Add preset" and enter the page "Preset edit".



Step 2: Choose the time. Tap "Name". As shown in the picture, its name is "baby room". For timer type, select "On". Then select the repeating days. Save the setting of preset name.

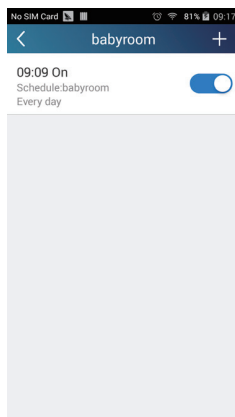

(3) Set device image

Please refer to step 1 in 2(1)

3.Control functions

(1) Common control functions: General control on the operation of smart devices (On/Off, temperature, fan speed, mode, etc.) and the setting of advanced functions (air exchange, dry, health, light, sleep, energy saving upper limit).



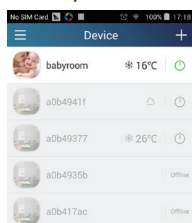

Step 1: General control

Enter the homepage "Device" first. Take "babyroom" as an example.

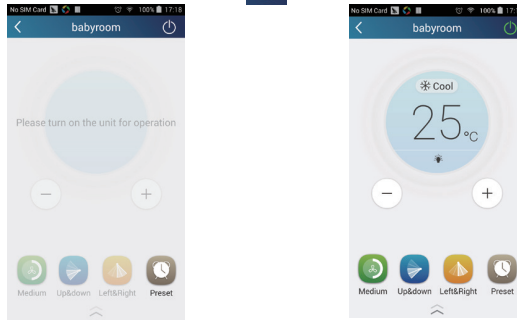

Tap "babyroom" and enter the page of air conditioner control. Tap  to turn on the control switch.



Tap  or  to increase or decrease temperature. Tap to  change working mode. Tap  to enter the page of fan speed adjustment.

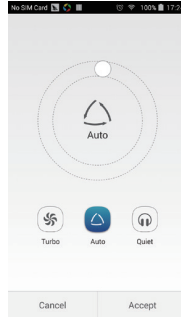

Tap  and go around the circle to adjust fan speed.

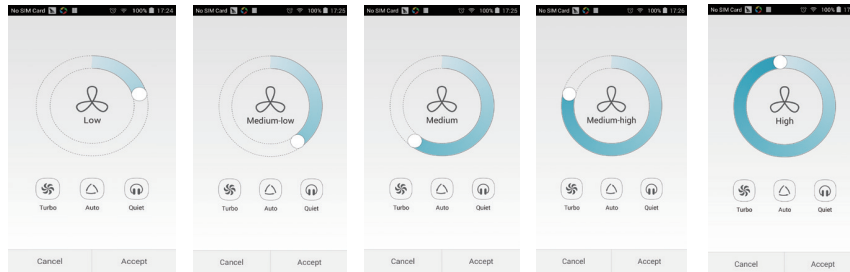

Step 2: Advanced settings

Tap  to enter advanced settings. You may select "Air", "Dry", "Health", "Light", "Sleep" or "Energy saving".

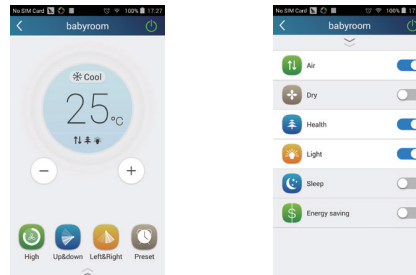

(2) Advanced control functions; Set scene; Preset; Link: Infrared control(only applicable to smart phones with infrared emitter)

Set scene: Preset the operation of several smart devices by one tap. On the page "Device", tap the image of "Device" to enter the page "Edit scene".



Tap "Add scene" and edit the scene name, for example, "Back home". Add execution devices.

Tap  to add commands. On the page "Select execution device", select the air conditioner named "babyroom". Then select "ON" or "OFF".

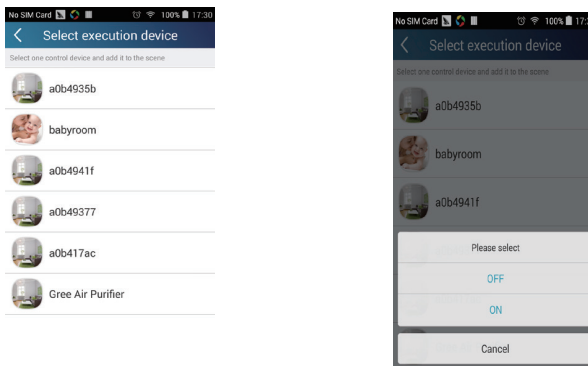

Continue to select the next execution device as instructed above. Tap **0.5s** to set the interval.

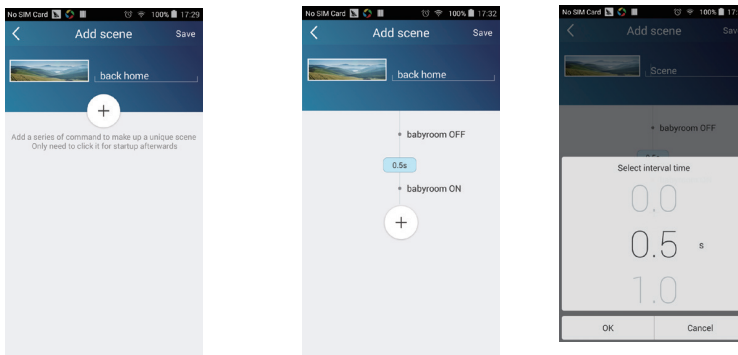

Tap "Save". Tap the scene picture displayed on homepage "Device" to send the command. Then the scene "Back home" will be in execution. You may view the execution condition of the scene.

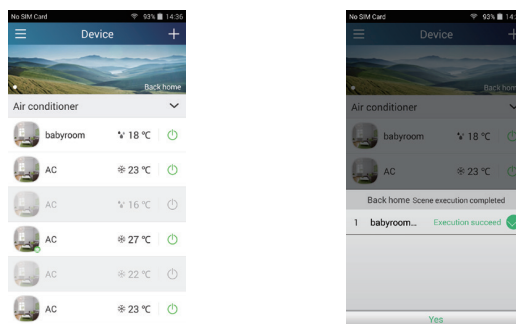

(3) Preset includes single-device preset and multi-device preset

Single-device preset: This can preset a certain device to be On/Off at a specific time.

On the homepage "Device", take air conditioner "babyroom" as an example. Tap  at the bottom of the page "babyroom". Then you will enter the page "Preset edit".

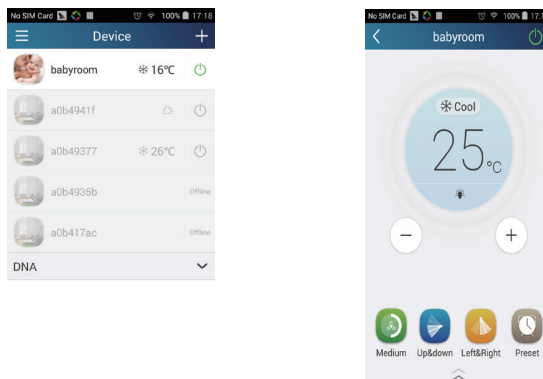

Slide up and down to set the time. If you need to synchronize the time, tap "synchronize". If such "Hint" interface doesn't show up, please skip this operation step.

Tap "Name" to customize the preset name.

Preset device can't be selected and it will default to "babyroom". Select "On" for the timer type. Select repeating days to complete the preset.

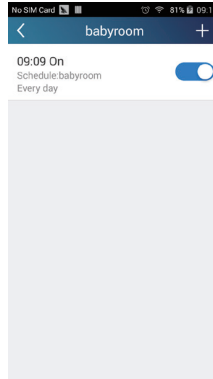

Multi-device preset: This can preset multiple devices to execute a command at a specific time.

Please refer to the instructions as how to set preset time, name, timer type and repeating days for a single device.

Tap "Preset device" to select one or more devices. Then return to the page "Device".

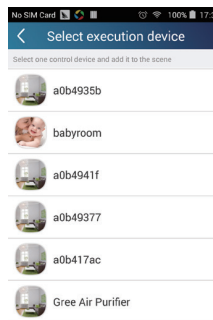

(4) Link(This function is applicable to some models)

Select a master device. When the environment satisfies the parameters as set in the master device, slave devices will execute commands to realize devices linkage.

Step 1: Set the parameters of master device (Select master device, select environment parameters, select master device status).

Tap **+** at the top right corner of the homepage "Device". Select "Link" and enter the page "Add linkage". Tap "Device/Param" to enter the page "Select device". Take "baby room" as an example. Tap "babyroom".

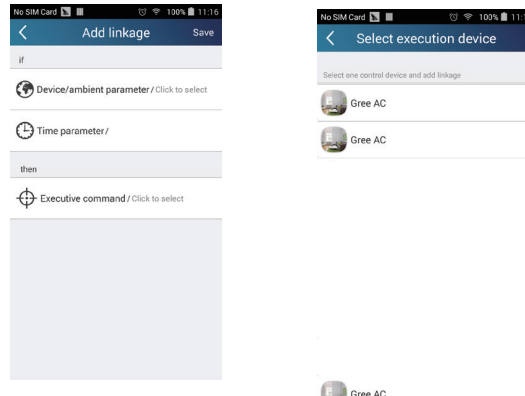

Enter the page "Select environment parameters".

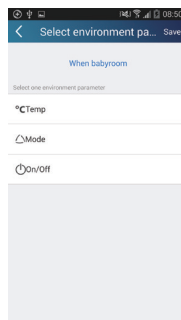

Tap "Temperature" to enter the page "Select temperature parameter". Slide up or down to adjust temperature. Tap "Upper limit" or "Lower limit".

Tap "Mode" and "On/Off" to select the status of master device. Then tap "Save".

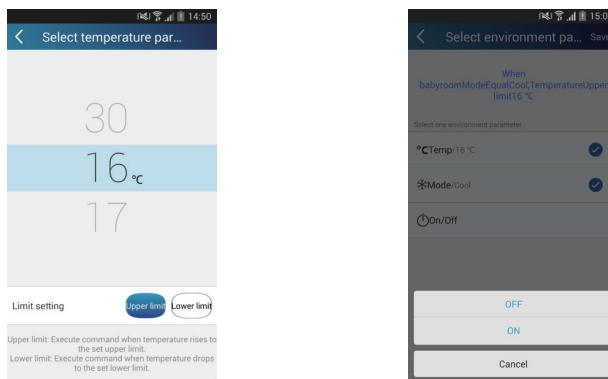

Step 2: Set time parameter for linkage. Tap "Time parameter" to enter the page "Set time". Slide rightwards to turn on the setting time.

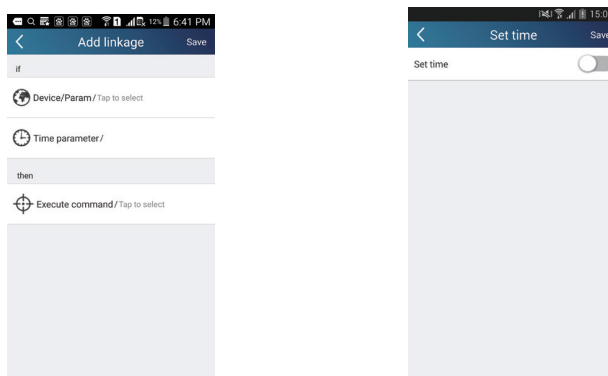

Tap "Execution time"; then tap "Start" and "Stop" to set start time and stop time respectively. Tap "OK" at the top right corner to save the setting.

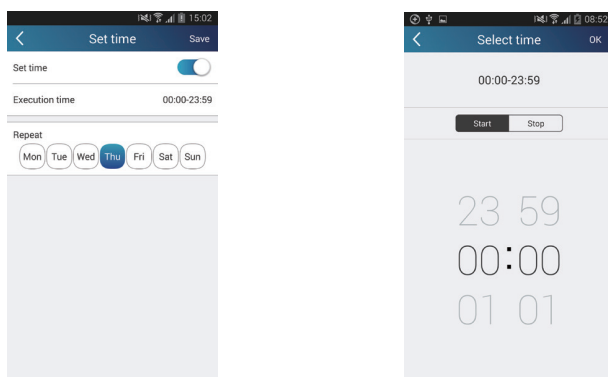

Tap the days below "Repeat" to select the repeating days. Then tap "Save".

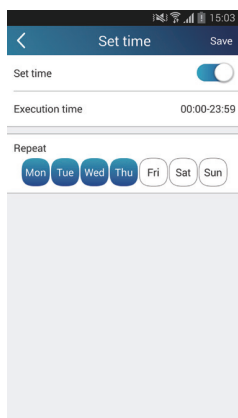

Step 3: Select "Execute command" Tap "Execute command" and enter the page "Select device".

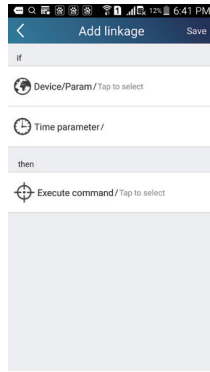

Tap the name of device that you want to control. Tap "ON" or "OFF" and then tap "Save" to complete the linkage.

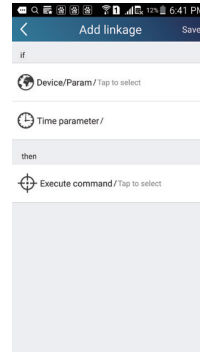
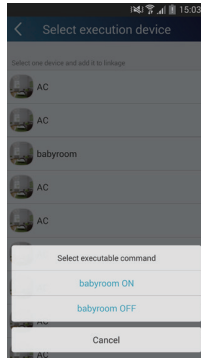

Tap "Save" and then repeat the above steps to set linkage of several scenes.

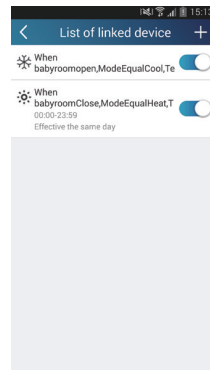
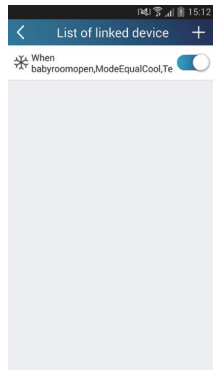

4.Menu functions

Menu functions (Share, Set, History, Feedback)

(1) Share: To share quick configuration information and unit's information, including local export and local import. For local import, you just need to tap "Local import" and wait for the data download.

Local export

Step 1: Export local data to another smart phone.

Enter menu page on the left side and tap "Share" to enter the page "Share". Then tap "Local export".

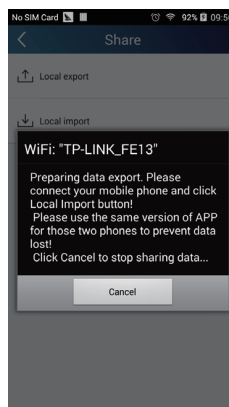

Step 2: Another smart phone to be imported.
Tap the model name and wait for the download.

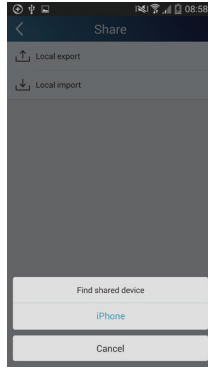

Notice:

This function requires that the two phones are of the same operating system. They are either Android phones or Apple phones, and are connecting to the same wireless router.

(2) Backup: To keep backup of the quick configuration information and unit's information, including backup to cloud and backup list on the cloud.

Backup to cloud

Enter the menu page on the left and tap "Backup".

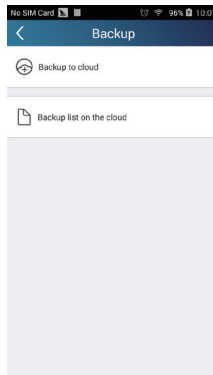

Tap "Backup to cloud" and then tap "Yes". Then wait for the data download.

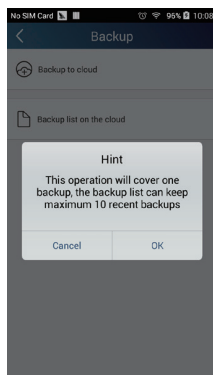

Select "Backup list on the cloud". Then backup records will appear. Tap "Record" to download data and recover data to local unit.

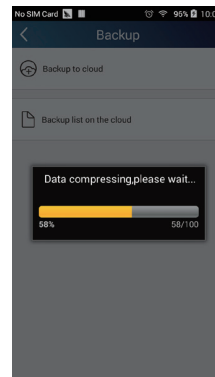
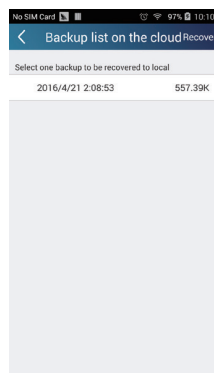

(3) Settings

User can set vibration, message alerts, server, updates, etc. The server setting here must be the same as the server setting in "Configuration" mentioned before. Otherwise, remote control will be invalid.

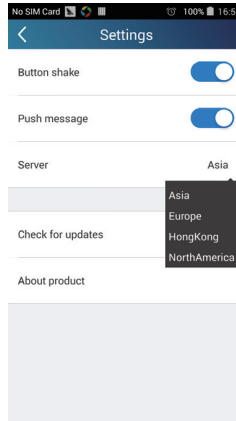

(4) Help

Please refer to "Help" of APP for the instruction of the latest functions.

6.4 Brief Description of Modes and Functions

1. Temperature Parameters

- ◆ Indoor preset temperature (T_{preset})
- ◆ Indoor ambient temperature ($T_{\text{amb.}}$)

2. Basic Functions

Once energized, in no case should the compressor be restarted within less than 3 minutes. In the situation that memory function is available, for the first energization, if the compressor is at stop before de-energization, the compressor will be started without a 3-minute lag; if the compressor is in operation before de-energization, the compressor will be started with a 3-minute lag; and once started, the compressor will not be stopped within 6 minutes regardless of changes in room temperature.

(1) Cooling Mode

① The condition and process of cooling

If $T_{\text{amb.}} \geq T_{\text{preset}}$ cooling mode will act, the compressor and outdoor fan will run, and the indoor fan will run at the set speed.

If $T_{\text{amb.}} \leq T_{\text{preset}} - 2^{\circ}\text{C}$, the compressor will stop, the outdoor fan will delay 30 seconds to stop, and the indoor fan will run at the set speed.

If $T_{\text{preset}} - 2^{\circ}\text{C} < T_{\text{amb.}} < T_{\text{preset}}$, the unit will keep running in the previous mode.

When $0 \leq T_{\text{preset}} - T_{\text{amb.}} < 2^{\circ}\text{C}$, if indoor fan speed is high, it will turn to medium fan speed; if indoor fan speed is medium or low, it will keep the same; (this condition will be valid only when the compressor is operating); if indoor fan speed is super high, it will keep the same;

When $T_{\text{amb.}} - T_{\text{preset}} \geq 1^{\circ}\text{C}$, the fan speed will return to set fan speed;

In this mode, the reversal valve will not be powered on and the temperature setting range is $16 \sim 30^{\circ}\text{C}$.

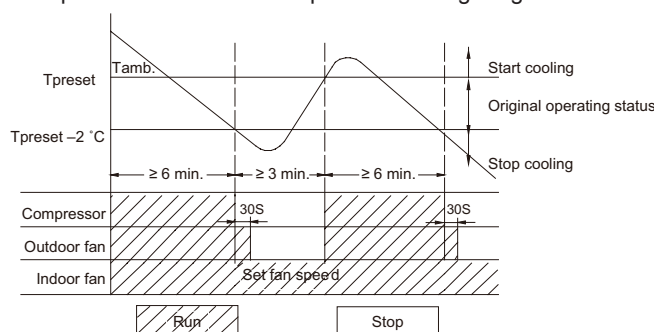

② Protection function

◆ Overcurrent protection

If total current is high, the compressor will run in limited frequency. If total current is too high, the compressor will stop, the outdoor fan will delay 30 seconds to stop, indoor unit will display E5 and out door yellow light will blink 5 times.

◆ Antifreezing protection

When the antifreezing protection is detected, the compressor will stop, the outdoor fan will stop after 30 seconds, and the indoor fan and swing motor will keep running in the original mode. When antifreezing protection is eliminated and the compressor has stopped for 3 minutes, the compressor will resume running in the original mode.

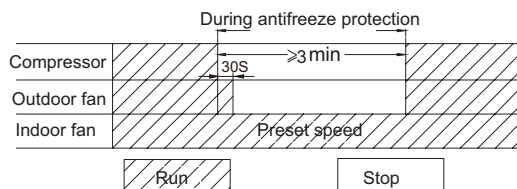

(2) Dehumidifying Mode

① Working conditions and process of dehumidifying

If $T_{\text{amb.}} > T_{\text{preset}}$, the unit will enter cooling and dehumidifying mode, in which case the compressor and the outdoor fan will operate and the indoor fan will run at low speed.

If $T_{\text{preset}} - 2^{\circ}\text{C} \leq T_{\text{amb.}} \leq T_{\text{preset}}$, the compressor remains at its original operation state.

If $T_{\text{amb.}} < T_{\text{preset}} - 2^{\circ}\text{C}$, the compressor will stop, the outdoor fan will stop with a time lag of 30s, and the indoor fan will operate at low speed.

② Protection function

Protection is the same as that under the cooling mode.

(3) Heating Mode

① The condition and process of heating

If $T_{\text{amb.}} \leq T_{\text{preset}} + 2^{\circ}\text{C}$, heating mode will act, the compressor, outdoor fan and reversal valve will run, the indoor fan will delay 3min to stop at the latest

If $T_{\text{preset}} + 2^{\circ}\text{C} < T_{\text{amb.}} < T_{\text{preset}} + 5^{\circ}\text{C}$, the unit will keep running in the original mode.

If $T_{\text{amb.}} \geq T_{\text{preset}} + 5^{\circ}\text{C}$, the compressor will stop, the outdoor fan will delay 30s to stop and indoor fan will blow 60s at low speed, the fan speed cannot be shifted within blow residual heat.

◆ In this mode, the temperature setting range is $16 \sim 30^{\circ}\text{C}$.

◆ The air conditioner will adjust the running frequency of the compressor automatically according to the change of ambient temperature.

◆ When the unit is turned off in heating mode, or switched to other mode from heating mode, the four-way valve will be powered off after the compressor stops.

◆ When compressor is running (not including each malfunction and protection):

- a. When outdoor ambient temperature $\geq 20^{\circ}\text{C}$ and indoor fan speed is low or medium, the fan speed will turn to high; if indoor fan speed is high or super high, it will keep the same.
- b. When outdoor ambient temperature $\leq 18^{\circ}\text{C}$, the fan speed will resume set fan speed.
- c. When $18^{\circ}\text{C} < \text{outdoor ambient temperature} < 20^{\circ}\text{C}$, it will run at present fan speed (set fan speed or high fan speed); but when first exiting cold air prevention after entering heating mode, it will run in set fan speed.

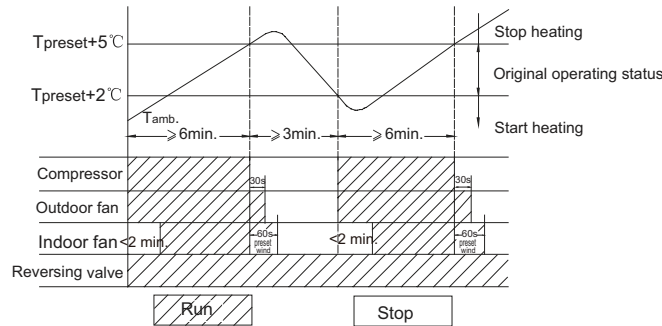

② Condition and process of defrost

When duration of successive heating operation is more than 45 minutes, or accumulated heating time more than 90 minutes, and one of the following conditions is reached, the unit will enter the defrost mode after 3 minutes.

- (1) $T \text{ outdoor ambient} > 5^{\circ}\text{C}$, $T \text{ outdoor tube} \leq -2^{\circ}\text{C}$;
- (2) $-2^{\circ}\text{C} \leq T \text{ outdoor ambient} < 5^{\circ}\text{C}$, $T \text{ outdoor tube} \leq -6^{\circ}\text{C}$;
- (3) $-5^{\circ}\text{C} \leq T \text{ outdoor ambient} < -2^{\circ}\text{C}$, $T \text{ outdoor tube} \leq -8^{\circ}\text{C}$;
- (4) $-10^{\circ}\text{C} \leq T \text{ outdoor ambient} < -5^{\circ}\text{C}$, $T \text{ outdoor tube} - T \text{ compensatory} \leq (T \text{ outdoor ambient} - 3^{\circ}\text{C})$
- (5) $T \text{ outdoor ambient} < -10^{\circ}\text{C}$, $T \text{ outdoor tube} - T \text{ compensatory} \leq (T \text{ outdoor ambient} - 3^{\circ}\text{C})$

(after energizing, $T \text{ compensatory} = 0^{\circ}\text{C}$ during the first defrosting; if it is not the first defrosting, $T \text{ compensatory}$ is confirmed by $T \text{ outdoor tube}$ of quitting last defrosting: a. when $T \text{ outdoor tube} > 2^{\circ}\text{C}$, $T \text{ compensatory} = 0^{\circ}\text{C}$; b. when $T \text{ outdoor tube} \leq 2^{\circ}\text{C}$, $T \text{ compensatory} = 3^{\circ}\text{C}$)

At that time, the indoor fan stops and the compressor stops, and after 30 seconds the outer fan will stop, and then after 30 seconds, the four-way valve will stop. After 30 seconds, the compressor is initiated for raising the frequency to defrost frequency. When the compressor has operated under defrost mode for 7.5 minutes, or $T \text{ outdoor ambient} \geq 10^{\circ}\text{C}$, the compressor will be converted to 46Hz operation. After 30 seconds, the compressor will stop. And after another 30 seconds, the four-way valve will be opened, and after 60 seconds, the compressor and the outer fan will be started, the indoor fan will run under preset cold air prevention conditions, and H1 will be displayed at temperature display area on the display panel. Defrost frequency is 85Hz.

③ Protection

◆ Cold air prevention

The unit is started under heating mode (the compressor is ON):

① In the case of $T \text{ indoor amb.} < 24^{\circ}\text{C}$: if $T \text{ tube} \leq 40^{\circ}\text{C}$ and the indoor fan is at stop state, the indoor fan will begin to run at low speed with a time lag of 2 minutes. Within 2 minutes, if $T \text{ tube} > 40^{\circ}\text{C}$, the indoor fan also will run at low speed; and after 1-minute operation at low speed, the indoor fan will be converted to operation at preset speed. Within 1-minute low speed operation or 2-minute nonoperation, if $T \text{ tube} > 42^{\circ}\text{C}$, the fan will run at present speed.

② In the case of $T \text{ indoor amb.} \geq 24^{\circ}\text{C}$: if $T \text{ tube} \leq 42^{\circ}\text{C}$, the indoor fan will run at low speed, and after one minute, the indoor fan will be converted to preset speed. Within one-minute low speed operation, if $T \text{ tube} > 42^{\circ}\text{C}$, the indoor fan will be converted to preset speed.

Note: $T \text{ indoor amb.}$ indicated in ① and ② refers to, under initially heating mode, the indoor ambient temperature before the command to start the compressor is performed according to the program, or after the unit is withdrawn from defrost, the indoor ambient temperature before the defrost symbol is cleared.

◆ Total current up and frequency down protection

If the total current $I_{\text{total}} \leq W$, frequency rise will be allowed; if $I_{\text{total}} \geq X$, frequency rise will not be allowed; if $I_{\text{total}} \geq Y$, the compressor will run at reduced frequency; and if $I_{\text{total}} \geq Z$, the compressor will stop and the outdoor fan will stop with a time lag of 30s.

09k: $W=5\text{A}; X=6\text{A}; Y=7\text{A}; Z=8\text{A}$

12k: $W=6\text{A}; X=7\text{A}; Y=8\text{A}; Z=9\text{A}$

(5) Fan Mode

Under the mode, the indoor fan will run at preset speed and the compressor, the outdoor fan, the four-way valve and the electric heater will stop.

Under the mode, temperature can be set within a range of $16 \sim 30^{\circ}\text{C}$.

(6) AUTO Mode

① Operation way of AUTO mode

a. When $T_{\text{ambient}} \geq 26^{\circ}\text{C}$, it will run in cooling mode. The implied set temperature is 25°C (note: the set temperature sending to outdoor unit is 25°C).

b. For heating and cooling unit, when $T_{\text{ambient}} \leq 22^{\circ}\text{C}$, it will run in heating mode. The implied set temperature is 20°C ; for cooling only unit, when $T_{\text{ambient}} \leq 22^{\circ}\text{C}$, it will run in fan mode and the displayed set temperature is 25°C .

c. For heating and cooling unit, when $22^{\circ}\text{C} < T_{\text{indoor ambient}} < 26^{\circ}\text{C}$ (for cooling only unit, $22^{\circ}\text{C} < T_{\text{indoor ambient}} < 26^{\circ}\text{C}$), it will keep the original running mode. If the unit is energized for the first time, it will run in fan mode.

② Protection

- a. In cooling operation, protection is the same as that under the cooling mode;
- b. In heating operation, protection is the same as that under the heating mode;
- c. When ambient temperature changes, operation mode will be converted preferentially. Once started, the compressor will remain unchanged for at least 6 minutes.

(7) Common Protection Functions and Fault Display under COOL, HEAT, DRY and AUTO Modes

① Overload protection

T_{tube} : measured temperature of outdoor heat exchanger under cooling mode; and measured temperature of indoor heat exchanger under heating mode.

1) Cooling overload

- a. If $T_{\text{tube}} \leq 52^{\circ}\text{C}$, the unit will return to its original operation state.
- b. If $T_{\text{tube}} \geq 55^{\circ}\text{C}$, frequency rise is not allowed.
- c. If $T_{\text{tube}} \geq 58^{\circ}\text{C}$, the compressor will run at reduced frequency.
- d. If $T_{\text{tube}} \geq 62^{\circ}\text{C}$, the compressor will stop and the indoor fan will run at preset speed.

2) Heating overload

- a. If $T_{\text{tube}} \leq 50^{\circ}\text{C}$, the unit will return to its original operation state.
- b. If $T_{\text{tube}} \geq 53^{\circ}\text{C}$, frequency rise is not allowed.
- c. If $T_{\text{tube}} \geq 56^{\circ}\text{C}$, the compressor will run at reduced frequency.
- d. If $T_{\text{tube}} \geq 60^{\circ}\text{C}$, the compressor will stop and the indoor fan will blow residue heat and then stop.

② Exhaust temperature protection of compressor

- If exhaust temperature $\geq 98^{\circ}\text{C}$, frequency is not allowed to rise.
- If exhaust temperature $\geq 103^{\circ}\text{C}$, the compressor will run at reduced frequency.
- If exhaust temperature $\geq 110^{\circ}\text{C}$, the compressor will stop.
- If exhaust temperature $\leq 90^{\circ}\text{C}$ and the compressor has stayed at stop for at least 3 minutes, the compressor will resume its operation.

③ Communication fault

If the unit fails to receive correct signals for durative 3 minutes, communication fault can be justified and the whole system will stop.

④ Module protection

Under module protection mode, the compressor will stop. When the compressor remains at stop for at least 3 minutes, the compressor will resume its operation. If module protection occurs six times in succession, the compressor will not be started again.

⑤ Overload protection

If temperature sensed by the overload sensor is over 115, the compressor will stop and the outdoor fan will stop with a time lag of 30 seconds. If temperature is below 95, the overload protection will be relieved.

⑥ DC bus voltage protection

If voltage on the DC bus is below 150V or over 420V, the compressor will stop and the outdoor fan will stop with a time lag of 30 seconds. When voltage on the DC bus returns to its normal value and the compressor has stayed at stop for at least 3 minutes, the compressor will resume its operation.

⑦ Faults of temperature sensors

Designation of sensors	Faults
Indoor ambient temperature	The sensor is detected to be open-circuited or short-circuited for successive 5 seconds
Indoor tube temperature	The sensor is detected to be open-circuited or short-circuited for successive 5 seconds
Outdoor ambient temperature	The sensor is detected to be open-circuited or short-circuited for successive 30 seconds
Outdoor tube temperature	The sensor is detected to be open-circuited or short-circuited for successive 30 seconds, and no detection is performed within 10 minutes after defrost begins.
Exhaust	After the compressor has operated for 3 minutes, the sensor is detected to be open-circuited or short-circuited for successive 30 seconds.
Overload	After the compressor has operated for 3 minutes, the sensor is detected to be open-circuited or short-circuited for successive 30 seconds.

3. Other Controls

(1) ON/OFF

Press the remote button ON/OFF: the on-off state will be changed once each time you press the button.

(2) Mode Selection:

Press the remote button MODE, then select and show in the following ways: AUTO, COOL, DRY, FAN, HEAT, AUTO.

(3) Temperature Setting Option Button

Each time you press the remote button TEMP+ or TEMP-, the setting temperature will be up or down by 1°C . Regulating Range: $16\sim 30^{\circ}\text{C}$, the button is useless under the AUTO mode.

(4) Time Switch

You should start and stop the machine according to the setting time by remote control.

(5) SLEEP State Control

1. In cooling mode:

- 1.1 When the initial set temperature is 16-23°C, the temperature will rise 1°C by every hour after sleep function is set; the temperature will not change after rising 3°C; after running for 7 hours, the temperature will decrease 1°C and it will not change after that.
- 1.2 When the initial set temperature is 24-27°C, the temperature will rise 1°C by every hour after sleep function is set; the temperature will not change after rising 2°C; after running for 7 hours, the temperature will decrease 1°C and it will not change after that.
- 1.3 When the initial set temperature is 28-29°C, the temperature will rise 1°C by every hour after sleep function is set; the temperature will not change after rising 1°C; after running for 7 hours, the temperature will decrease 1°C and it will not change after that.
- 1.4 When the initial set temperature is 30°C, the unit will keep on running at this temperature; after running for 7 hours, the temperature will decrease 1°C and it will not change after that.

Relationship between set temperature and running time:

Initial Temp.	Running time(T)							
0(start)	1	2	3	4	5	6	7	8
16	17	18	19	19	19	19	18	18
17	18	19	20	20	20	20	19	19
18	19	20	21	21	21	21	20	20
19	20	21	22	22	22	22	21	21
20	21	22	23	23	23	23	22	22
21	22	23	24	24	24	24	23	23
22	23	24	25	25	25	25	24	24
23	24	25	26	26	26	26	25	25
24	25	26	26	26	26	26	25	25
25	26	27	27	27	27	27	26	26
26	27	28	28	28	28	28	27	27
27	28	29	29	29	29	29	28	28
28	29	29	29	29	29	29	28	28
29	30	30	30	30	30	30	29	29
30	30	30	30	30	30	30	29	29

2. In heating mode:

- 2.1 When the initial set temperature is 16°C, the unit will keep on running at this temperature;
- 2.2 When the initial set temperature is 17-20°C, the temperature will decrease 1°C by every hour after sleep function is set; the temperature will not change after decreasing 1°C;
- 2.3 When the initial set temperature is 21-27°C, the temperature will decrease 1°C by every hour after sleep function is set; the temperature will not change after decreasing 2°C;
- 2.4 When the initial set temperature is 28-30°C, the temperature will decrease 1°C by every hour after sleep function is set; the temperature will not change after decreasing 3°C;

Relationship between set temperature and running time:

Initial Temp.	Running time(T)							
0(start)	1	2	3	4	5	6	7	8
16	16	16	16	16	16	16	16	16
17	16	16	16	16	16	16	16	16
18	17	17	17	17	17	17	17	17
19	18	18	18	18	18	18	18	18
20	19	19	19	19	19	19	19	19
21	20	19	19	19	19	19	19	19
22	21	20	20	20	20	20	20	20
23	22	21	21	21	21	21	21	21
24	23	22	22	22	22	22	22	22
25	24	23	23	23	23	23	23	23
26	25	24	24	24	24	24	24	24
27	26	25	25	25	25	25	25	25
28	27	26	25	25	25	25	25	25
29	28	27	26	26	26	26	26	26
30	29	28	27	27	27	27	27	27

(6) Indoor Fan Control

Indoor fan could be set at ultra-high, high, medium, low speed by wireless remote controller and operated as that speed. Auto fan speed could be set as well, indoor fan will operate under auto fan speed as following:

1. Under heating mode: auto speed under heating or auto heating mode:

- When $T_{amb.} \leq T_{preset} + 1^{\circ}\text{C}$, indoor fan will operate at high speed;
- When $T_{preset} + 1^{\circ}\text{C} < T_{amb.} < T_{preset} + 3^{\circ}\text{C}$, indoor fan will operate at medium speed;
- When $T_{amb.} \geq T_{preset} + 3^{\circ}\text{C}$, indoor fan will operate at low speed;

There should be at least 180s operation time during switchover of each speed.

2. Under cooling mode: auto speed under cooling or auto cooling mode:

- When $T_{amb.} \geq T_{preset} + 2^{\circ}\text{C}$, indoor fan will operate at high speed;
- When $T_{preset} < T_{amb.} < T_{preset} + 2^{\circ}\text{C}$, indoor fan will operate at medium speed;
- When $T_{amb.} \leq T_{preset}$, indoor fan will operate at low speed

There should be at least 210s operation time during switchover of each speed.

(7) Buzzer Control

The buzzer will send a “Di” sound when the air conditioner is powered up or received the information sent by the remote control or there is a button input, the single tube cooler doesn’t receive the remote control ON signal under the mode of heating mode.

(8) Auto button

If the controller is on, it will stop by pressing the button, and if the controller is off, it will be automatic running state by pressing the button, swing on and light on, and the main unit will run based on the remote control if there is remote control order.

(9) Up-and-Down Swinging Control

When power on, the up-and-down motor will firstly move the air deflector to 0 counter-clockwise, close the air outlet.

After starting the machine, if you don’t set the swinging function, heating mode and auto-heating mode, the up-and-down air deflector will move to D clockwise; under other modes, the up-and-down air deflector will move to L1. If you set the swinging function when you start the machine, then the wind blade will swing between L and D. The air deflector has 7 swinging states: Location L, Location A, Location B, Location C, Location D, Location L to Location D, stop at any location between L-D (the included angle between L~D is the same).

The air deflector will be closed at 0 Location, and the swinging is effectual only on condition that setting the swinging order and the inner fan is running. The indoor fan and compressor may get the power when air deflector is on the default location.

The indoor fan and compressor may get the power when air deflector is on the default location.

(10) Display

① Operation pattern and mode pattern display

All the display patterns will display for a time when the power on, the operation indication pattern will display in red under standby status. When the machine is start by remote control, the indication pattern will light and display the current operation mode (the mode light includes: Cooling, heating and dehumidify). If you close the light key, all the display patterns will close.

② Double-8 display

According to the different setting of remote control, the nixie light may display the current temperature (the temperature scope is from 16°C to 30°C) and indoor ambient temperature. The set temperature displayed in auto cooling and fan mode is 25°C and the set temperature displayed in auto heating mode is 20°C. Under heating mode, nixie tube displays H1 or heating indicator is off 0.5s and blinks 10s in defrosting. (If you set the fahrenheit temperature display, the nixie light will display according to fahrenheit temperature) (11) Protection function and failure display

E2: Freeze-proofing protection E4: Exhausting protection E5: Overcurrent protection E6: Communication failure

F1: Indoor ambient sensor start and short circuit (continuously measured failure in 5s)

F2: Indoor evaporator sensor start and short circuit (continuously measured failure in 5s)

F3: Outdoor ambient sensor start and short circuit (continuously measured failure in 30s)

F4: Outdoor condenser sensor start and short circuit (continuously measured failure in 30s, and don’t measure within 10 minutes after defrosted)

F5: Outdoor exhausting sensor start and short circuit (continuously measured failure in 30s after the compressor operated 3 minutes)

H3: Overload protection of compressor H5: Module protection PH: High-voltage protection PL: Low-voltage protection

P1: Nominal cooling and heating test P2: Maximum cooling and heating test

P3: Medium cooling and heating test P0: Minimum cooling and heating test

(12) Drying Function

You may start or stop the drying function under the modes of cooling and dehumidify at the starting status (The modes of automatism, heating and air supply do not have drying function). When you start the drying function, after stop the machine by pressing the switch button, you should keep running the inner fans for 2 minutes under low air damper (The swing will operate as the D1 status within 2 minutes, and other load is stopped), then stop the entire machine; When you stop the drying function, press the switch button will stop the machine directly. When you start the drying function, operating the drying button will stop the inner fans and close the guide louver.

(13) Memory Function

When interrupting the power supply memory content: mode, swing function, light, set temperature and wind speed.

After interrupted the power supply, the machine will start when recovering the power according to the memory content automatically.

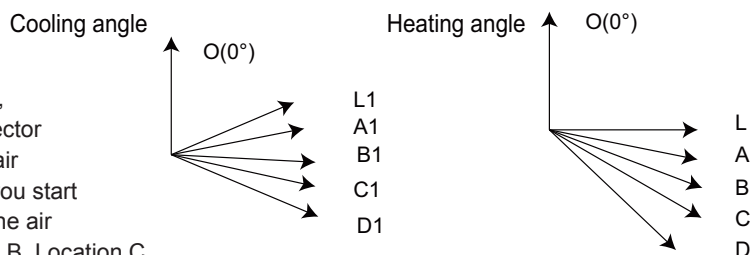

Part II : Installation and Maintenance

7. Notes for Installation and Maintenance

Safety Precautions: Important!

Please read the safety precautions carefully before installation and maintenance.

The following contents are very important for installation and maintenance.

Please follow the instructions below.

- The installation or maintenance must accord with the instructions.
- Comply with all national electrical codes and local electrical codes.
- Pay attention to the warnings and cautions in this manual.
- All installation and maintenance shall be performed by distributor or qualified person.
- All electric work must be performed by a licensed technician according to local regulations and the instructions given in this manual.
- Be caution during installation and maintenance. Prohibit incorrect operation to prevent electric shock, casualty and other accidents.



Warnings

Electrical Safety Precautions:

1. Cut off the power supply of air conditioner before checking and maintenance.
2. The air condition must apply specialized circuit and prohibit share the same circuit with other appliances.
3. The air conditioner should be installed in suitable location and ensure the power plug is touchable.
4. Make sure each wiring terminal is connected firmly during installation and maintenance.
5. Have the unit adequately grounded. The grounding wire can't be used for other purposes.
6. Must apply protective accessories such as protective boards, cable-cross loop and wire clip.
7. The live wire, neutral wire and grounding wire of power supply must be corresponding to the live wire, neutral wire and grounding wire of the air conditioner.
8. The power cord and power connection wires can't be pressed by hard objects.
9. If power cord or connection wire is broken, it must be replaced by a qualified person.

10. If the power cord or connection wire is not long enough, please get the specialized power cord or connection wire from the manufacture or distributor. Prohibit prolong the wire by yourself.

11. For the air conditioner without plug, an air switch must be installed in the circuit. The air switch should be all-pole parting and the contact parting distance should be more than 1/8 inch.

12. Make sure all wires and pipes are connected properly and the valves are opened before energizing.

13. Check if there is electric leakage on the unit body. If yes, please eliminate the electric leakage.

14. Replace the fuse with a new one of the same specification if it is burnt down; don't replace it with a cooper wire or conducting wire.

15. If the unit is to be installed in a humid place, the circuit breaker must be installed.

Installation Safety Precautions:

1. Select the installation location according to the requirement of this manual.(See the requirements in installation part)
2. Handle unit transportation with care; the unit should not be carried by only one person if it is more than 44.09lb.
3. When installing the indoor unit and outdoor unit, a sufficient fixing bolt must be installed; make sure the installation support is firm.
4. Wear safety belt if the height of working is above 78 3/4 inch.
5. Use equipped components or appointed components during installation.
6. Make sure no foreign objects are left in the unit after finishing installation.

Refrigerant Safety Precautions:

1. Avoid contact between refrigerant and fire as it generates poisonous gas; Prohibit prolong the connection pipe by welding.
2. Apply specified refrigerant only. Never have it mixed with any other refrigerant. Never have air remain in the refrigerant line as it may lead to rupture or other hazards.
3. Make sure no refrigerant gas is leaking out when installation is completed.
4. If there is refrigerant leakage, please take sufficient measure to minimize the density of refrigerant.
5. Never touch the refrigerant piping or compressor without wearing glove to avoid scald or frostbite.

Improper installation may lead to fire hazard, explosion, electric shock or injury.

8. Installation

8.1 Installation Dimension Diagram

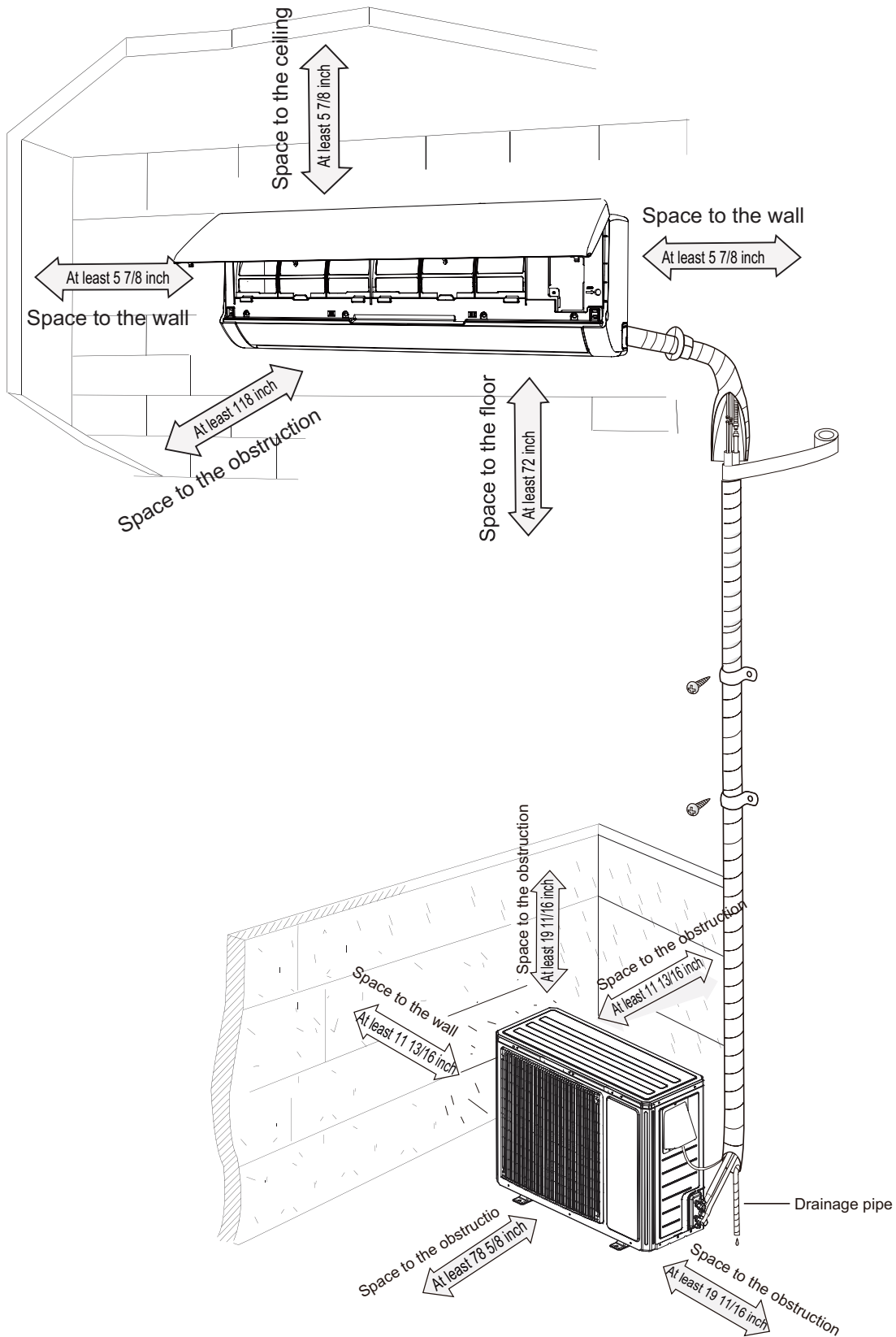

Installation procedures

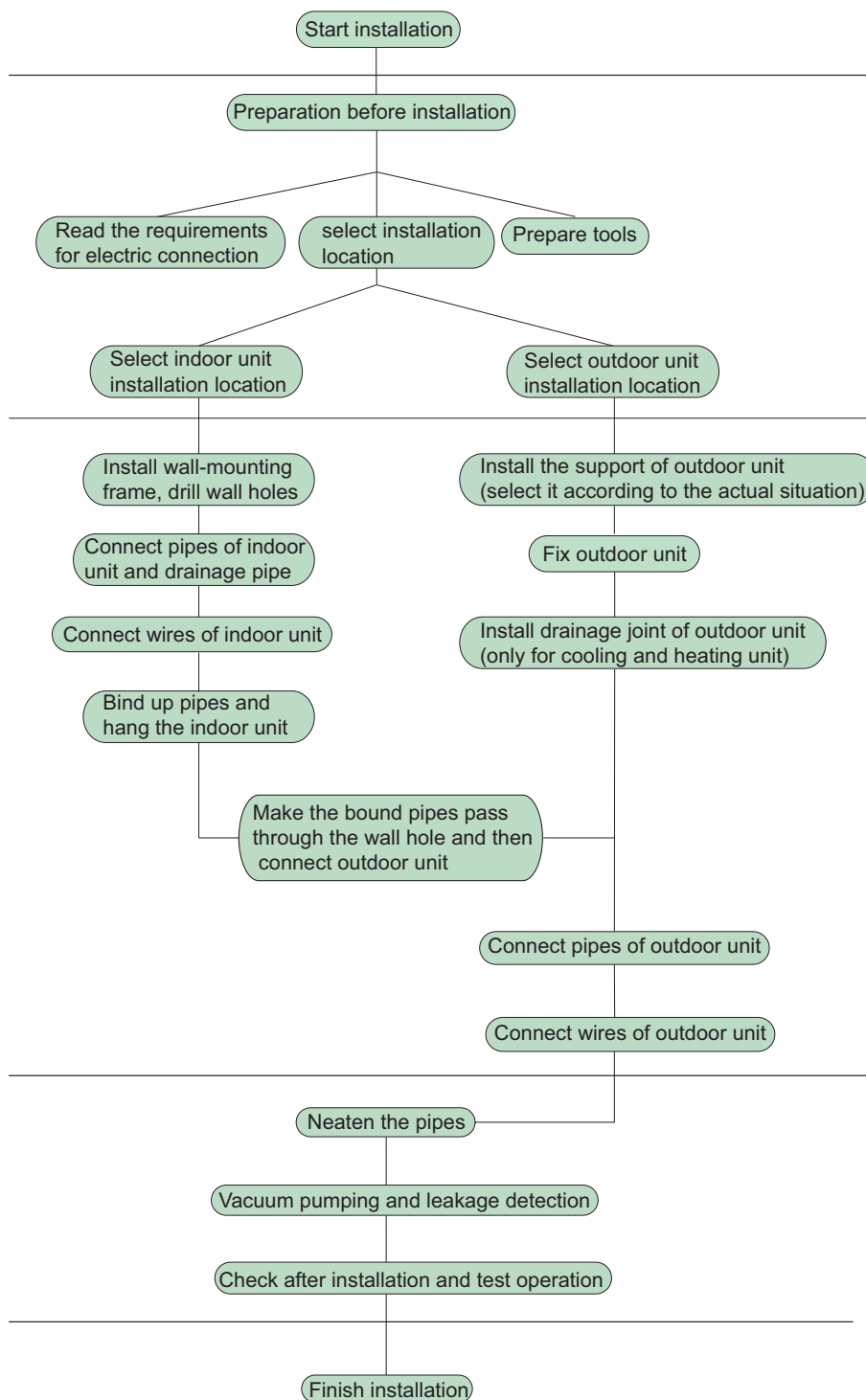

Note: this flow is only for reference; please find the more detailed installation steps in this section.

8.2 Installation Parts-checking

No.	Name	No.	Name
1	Indoor unit	8	Sealing gum
2	Outdoor unit	9	Wrapping tape
3	Connection pipe	10	Support of outdoor unit
4	Drainage pipe	11	Fixing screw
5	Wall-mounting frame	12	Drainage plug(cooling and heating unit)
6	Connecting cable(power cord)	13	Owner's manual, remote controller
7	Wall pipe		

⚠ Note:

1. Please contact the local agent for installation.
2. Don't use unqualified power cord.

8.3 Selection of Installation Location

1. Basic Requirement:

Installing the unit in the following places may cause malfunction. If it is unavoidable, please consult the local dealer:

- (1) The place with strong heat sources, vapors, flammable or explosive gas, or volatile objects spread in the air.
- (2) The place with high-frequency devices (such as welding machine, medical equipment).
- (3) The place near coast area.
- (4) The place with oil or fumes in the air.
- (5) The place with sulfureted gas.
- (6) Other places with special circumstances.
- (7) The appliance shall not be installed in the laundry.

2. Indoor Unit:

- (1) There should be no obstruction near air inlet and air outlet.
- (2) Select a location where the condensation water can be dispersed easily and won't affect other people.
- (3) Select a location which is convenient to connect the outdoor unit and near the power socket.
- (4) Select a location which is out of reach for children.
- (5) The location should be able to withstand the weight of indoor unit and won't increase noise and vibration.
- (6) The appliance must be installed 98 7/16 inch above floor.
- (7) Don't install the indoor unit right above the electric appliance.
- (8) Please try your best to keep way from fluorescent lamp.

3. Outdoor Unit:

- (1) Select a location where the noise and outflow air emitted by the outdoor unit will not affect neighborhood.
- (2) The location should be well ventilated and dry, in which the outdoor unit won't be exposed directly to sunlight or strong wind.
- (3) The location should be able to withstand the weight of outdoor unit.
- (4) Make sure that the installation follows the requirement of installation dimension diagram.
- (5) Select a location which is out of reach for children and far away from animals or plants. If it is unavoidable, please add fence for safety purpose.

8.4 Electric Connection Requirement

1. Safety Precaution

- (1) Must follow the electric safety regulations when installing the unit.
- (2) According to the local safety regulations, use qualified power supply circuit and air switch.
- (3) Make sure the power supply matches with the requirement of air conditioner. Unstable power supply or incorrect wiring may result in electric shock, fire hazard or malfunction. Please install proper power supply cables before using the air conditioner.

Air-conditioner	Air switch capacity
09/12K	15A

- (4) Properly connect the live wire, neutral wire and grounding wire of power socket.
- (5) Be sure to cut off the power supply before proceeding any work related to electricity and safety.
- (6) Do not put through the power before finishing installation.
- (7) If the supply cord is damaged, it must be replaced by the manufacturer, its service agent or similarly qualified persons in order to avoid a hazard.
- (8) The temperature of refrigerant circuit will be high, please keep the interconnection cable away from the copper tube.
- (9) The appliance shall be installed in accordance with national wiring regulations.

2. Grounding Requirement:

- (1) The air conditioner is first class electric appliance. It must be properly grounding with specialized grounding device by a professional. Please make sure it is always grounded effectively, otherwise it may cause electric shock.
- (2) The yellow-green wire in air conditioner is grounding wire, which can't be used for other purposes.
- (3) The grounding resistance should comply with national electric safety regulations.
- (4) The appliance must be positioned so that the plug is accessible.
- (5) An all-pole disconnection switch having a contact separation of at least 1/8 inch in all poles should be connected in fixed wiring.

8.5 Installation of Indoor Unit

1. Choosing Installation location

Recommend the installation location to the client and then confirm it with the client.

2. Install Wall-mounting Frame

- (1) Hang the wall-mounting frame on the wall; adjust it in horizontal position with the level meter and then point out the screw fixing holes on the wall.
- (2) Drill the screw fixing holes on the wall with impact drill (the specification of drill head should be the same as the plastic expansion particle) and then fill the plastic expansion particles

in the holes.

(3) Fix the wall-mounting frame on the wall with tapping screws (ST4.2X25TA) and then check if the frame is firmly installed by pulling the frame. If the plastic expansion particle is loose, please drill another fixing hole nearby.

3. Install Wall-mounting Frame

(1) Choose the position of piping hole according to the direction of outlet pipe. The position of piping hole should be a little lower than the wall-mounted frame.(As show in Fig.1)

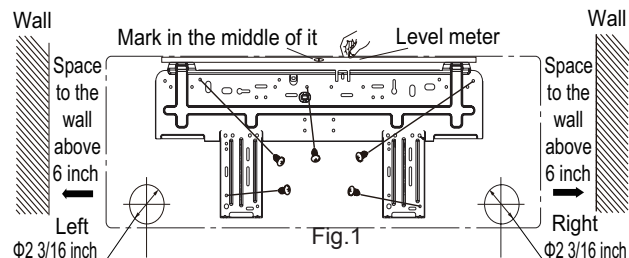

(2) Open a piping hole with the diameter of 2 3/16inch on the selected outlet pipe position. In order to drain smoothly, slant the piping hole on the wall slightly downward to the outdoor side with the gradient of 5-10°. (As show in Fig.2)

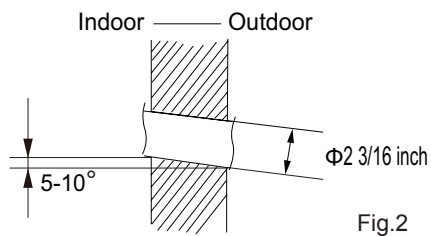

⚠ Note:

- (1) Pay attention to dust prevention and take relevant safety measures when opening the hole.
- (2) The plastic expansion particles are not provided and should be bought locally.

4. Outlet Pipe

- (1) The pipe can be led out in the direction of right, rear right, left or rear left.(As show in Fig.3)
- (2) When selecting leading out the pipe from left or right, please cut off the corresponding hole on the bottom case.(As show in Fig.4)

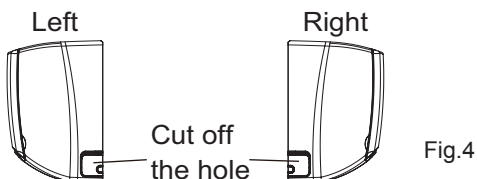
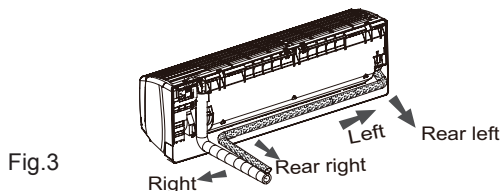

5. Connect the Pipe of Indoor Unit

- (1) Aim the pipe joint at the corresponding bellmouth.(As show in Fig.5)
- (2) Pretightening the union nut with hand.
- (3) Adjust the torque force by referring to the following sheet. Place the open-end wrench on the pipe joint and place the torque wrench on the union nut. Tighten the union nut with torque wrench.(As show in Fig.6)
- (4) Wrap the indoor pipe and joint of connection pipe with insulating pipe, and then wrap it with tape.(As show in Fig.7)

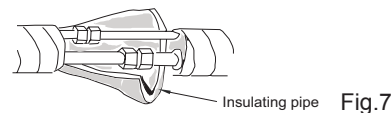
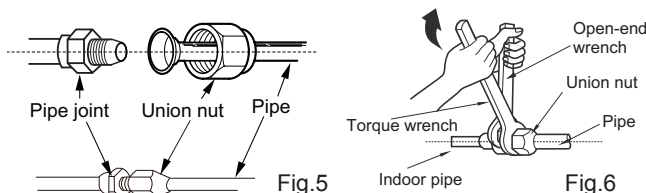

Refer to the following table for wrench moment of force:

Hex nut diameter(inch)	Tightening torque(ft-lbf)
Φ1/4	11.10~14.75
Φ3/8	20.12~29.50
Φ1/2	33.19~40.56
Φ5/8	44.24~47.94
Φ3/4	51.32~55.31

6. Install Drain Hose

- (1) Connect the drain hose to the outlet pipe of indoor unit.(As show in Fig.8)
- (2) Bind the joint with tape.(As show in Fig.9)

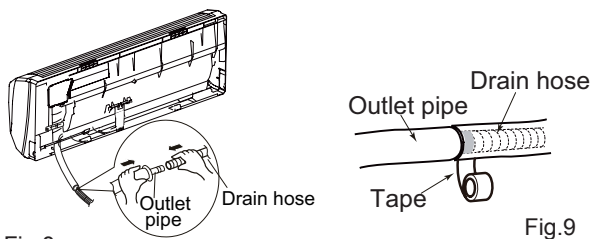

⚠ Note:

- (1) Add insulating pipe in the indoor drain hose in order to prevent condensation.
- (2) The plastic expansion particles are not provided. (As show in Fig.10)

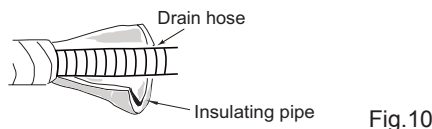

7. Connect Wire of Indoor Unit

(1) Open the panel, remove the screw on the wiring cover and then take down the cover.(As show in Fig.11)

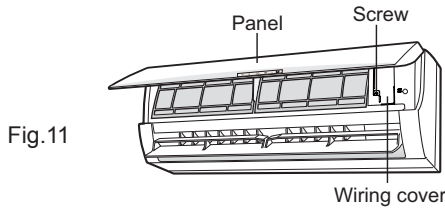

(2) Fix the wire crossing board on connection wire sleeve at the bottom case; let the connection wire sleeve go through the wire crossing hole at the back of indoor unit, and then pull it out from the front.(As show in Fig.12)

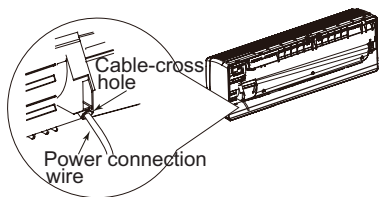

Fig.12

(3) Remove the wire clip; connect the power connection wire to the wiring terminal according to the color; tighten the screw and then fix the power connection wire with wire clip.After finishing wiring, clamp the grounding wire (yellow-green wire) into the wire-crossing groove (As show in Fig.13), in order to avoid pressing the wire when closing the electric box cover. (As show in Fig.13)

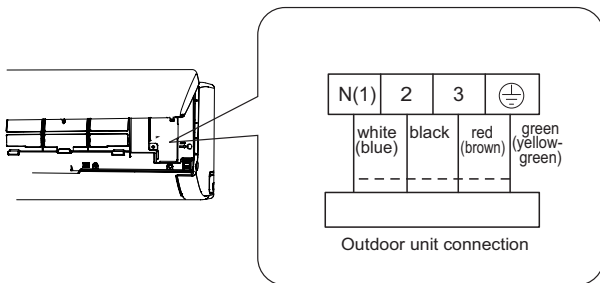

Fig.13

Note: the wiring board is for reference only,please refer to the actual one.

(4) Put wiring cover back and then tighten the screw.
(5) Close the panel.

⚠ Note:

- (1) All wires of indoor unit and outdoor unit should be connected by a professional.
- (2) If the length of power connection wire is insufficient, please contact the supplier for a new one. Avoid extending the wire by yourself.
- (3) For the air conditioner with plug, the plug should be reachable after finishing installation.
- (4) For the air conditioner without plug, an air switch must be installed in the line. The air switch should be all-pole parting and the contact parting distance should be more than 1/8inch.

8. Bind up Pipe

- (1) Bind up the connection pipe, power cord and drain hose with the band.(As show in Fig.14)
- (2) Reserve a certain length of drain hose and power cord for installation when binding them. When binding to a certain degree, separate the indoor power and then separate the drain hose.(As show in Fig.15)
- (3) Bind them evenly.
- (4) The liquid pipe and gas pipe should be bound separately at the end.

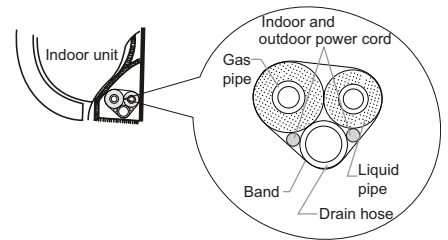

Fig.14

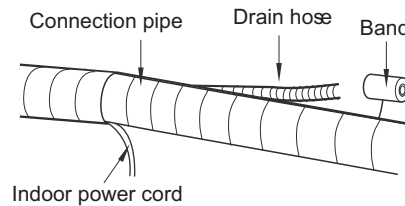

Fig.15

⚠ Note:

- (1) The power cord and control wire can't be crossed or winding.
- (2) The drain hose should be bound at the bottom.

9. Hang the Indoor Unit

- (1) Put the bound pipes in the wall pipe and then make them pass through the wall hole.
- (2) Hang the indoor unit on the wall-mounting frame.
- (3) Stuff the gap between pipes and wall hole with sealing gum.
- (4) Fix the wall pipe.(As show in Fig.16)
- (5) Check if the indoor unit is installed firmly and closed to the wall.(As show in Fig.17)

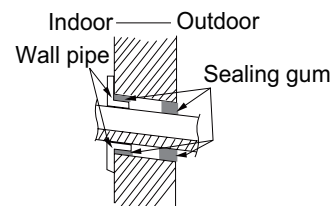

Fig.16

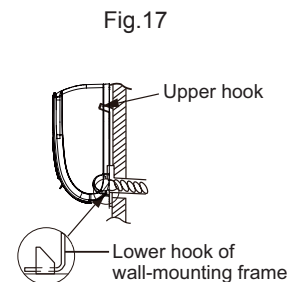

Fig.17

⚠ Note:

Do not bend the drain hose too excessively in order to prevent blocking.

8.6 Installation of Outdoor Unit

1. Fix the Support of Outdoor Unit(Select it according to the actual installation situation)

- (1) Select installation location according to the house structure.
- (2) Fix the support of outdoor unit on the selected location with expansion screws.

⚠ Note:

- (1) Take sufficient protective measures when installing the outdoor unit.
- (2) Make sure the support can withstand at least four times the unit weight.
- (3) The outdoor unit should be installed at least 3cm above the floor in order to install drain joint.(As show in Fig.18)
- (4) For the unit with cooling capacity of 2300W~5000W, 6 expansion screws are needed; for the unit with cooling capacity of 6000W~8000W, 8 expansion screws are needed; for the unit with cooling capacity of 10000W~16000W, 10 expansion screws are needed.

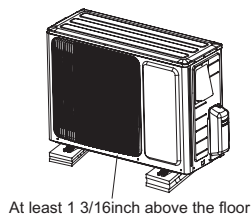

Fig.18

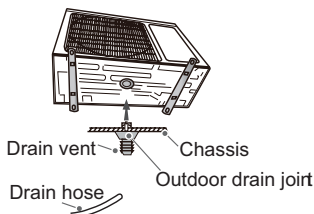

Fig.19

2. Install Drain Joint(Only for cooling and heating unit)

- (1) Connect the outdoor drain joint into the hole on the chassis.
 - (2) Connect the drain hose into the drain vent.
- (As show in Fig.19)

3. Fix Outdoor Unit

- (1) Place the outdoor unit on the support.
 - (2) Fix the foot holes of outdoor unit with bolts.
- (As show in Fig.20)

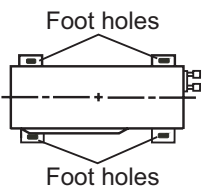

Fig.20

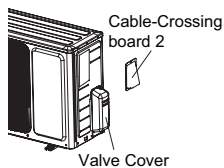

Fig.21

4. Connect Indoor and Outdoor Pipes

- (1) Remove the screw on the right Cable-Crossing board 2 or handle and valve cover of outdoor unit and then remove the Cable-Crossing board 2 or handle and valve cover.(As show in Fig.21)
- (2) Remove the screw cap of valve and aim the pipe joint at the bellmouth of pipe.(As show in Fig.22)

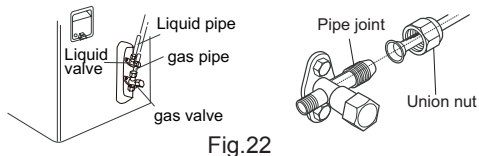

Fig.22

- (3) Pretightening the union nut with hand.
- (4) Tighten the union nut with torque wrench .

Refer to the following table for wrench moment of force:

Hex nut diameter(inch)	Tightening torque(ft·lbf)
Φ1/4	11.10~14.75
Φ3/8	20.12~29.50
Φ1/2	33.19~40.56
Φ5/8	44.24~47.94
Φ3/4	51.32~55.31

5. Connect Outdoor Electric Wire

- (1)Remove the wire clip; connect the power connection wire and signal control wire (only for cooling and heating unit) to the wiring terminal according to the color; fix them with screws. (As show in Fig.23)
- (2)Fix the power connection wire and signal control wire with wire clip (only for cooling and heating unit).

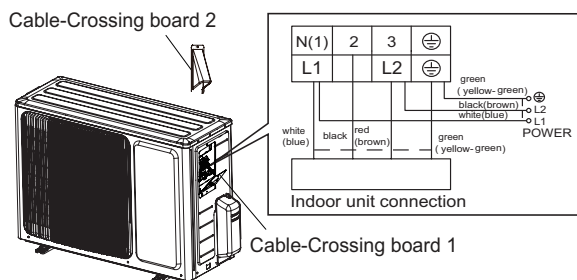

Note: the wiring board is for reference only,please refer to the actual one.

Fig.23

⚠ Note:

- (1) After tightening the screw, pull the power cord slightly to check if it is firm.
- (2) Never cut the power connection wire to prolong or shorten the distance.

6. Neaten the Pipes

- (1) The pipes should be placed along the wall, bent reasonably and hidden possibly. Min. semidiameter of bending the pipe is 3 15/16 inch.
- (2) If the outdoor unit is higher than the wall hole, you must set a U-shaped curve in the pipe before pipe goes into the room, in order to prevent rain from getting into the room.(As show in Fig.24)

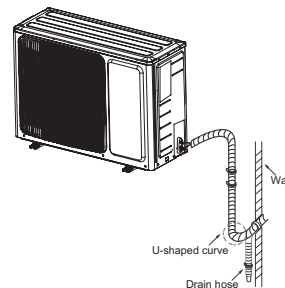

Fig.24

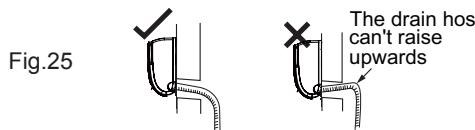
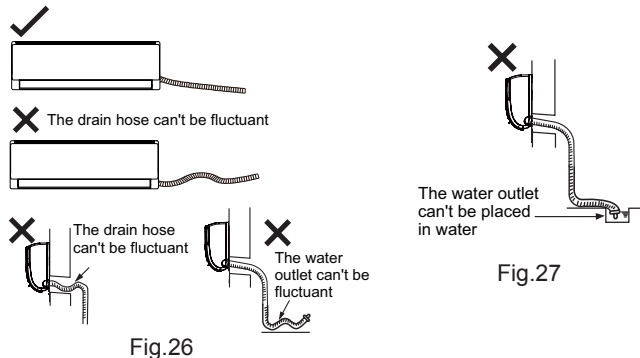

Fig.25

⚠ Note:

- (1) The through-wall height of drain hose shouldn't be higher than the outlet pipe hole of indoor unit.(As show in Fig.25)
- (2) Slant the drain hose slightly downwards. The drain hose can't be curved, raised and fluctuant, etc.(As show in Fig.26)
- (3) The water outlet can't be placed in water in order to drain smoothly.(As show in Fig.27)



8.7 Vacuum Pumping and Leak Detection

1. Use Vacuum Pump

- (1) Remove the valve caps on the liquid valve and gas valve and the nut of refrigerant charging vent.
- (2) Connect the charging hose of piezometer to the refrigerant charging vent of gas valve and then connect the other charging hose to the vacuum pump.
- (3) Open the piezometer completely and operate for 10-15min to check if the pressure of piezometer remains in -0.1MPa.
- (4) Close the vacuum pump and maintain this status for 1-2min to check if the pressure of piezometer remains in -0.1MPa. If the pressure decreases, there may be leakage.
- (5) Remove the piezometer, open the valve core of liquid valve and gas valve completely with inner hexagon spanner.
- (6) Tighten the screw caps of valves and refrigerant charging vent.(As show in Fig.28)

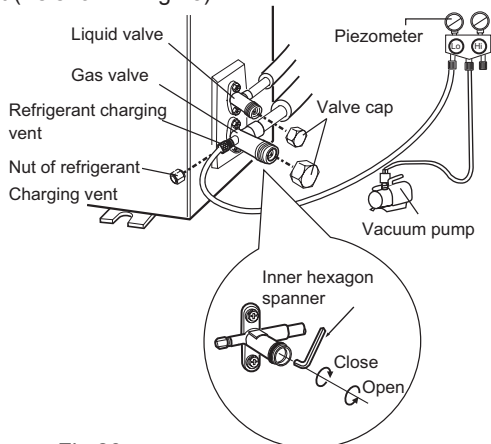

Fig.28

2. Leakage Detection

- (1) With leakage detector:
Check if there is leakage with leakage detector.
- (2) With soap water:
If leakage detector is not available, please use soap water for leakage detection. Apply soap water at the suspected position and keep the soap water for more than 3min. If there are air bubbles coming out of this position, there's a leakage.

8.8 Check after Installation and Test Operation

1. Check after Installation

Check according to the following requirement after finishing installation.

NO.	Items to be checked	Possible malfunction
1	Has the unit been installed firmly?	The unit may drop, shake or emit noise.
2	Have you done the refrigerant leakage test?	It may cause insufficient cooling (heating) capacity.
3	Is heat insulation of pipeline sufficient?	It may cause condensation and water dripping.
4	Is water drained well?	It may cause condensation and water dripping.
5	Is the voltage of power supply according to the voltage marked on the nameplate?	It may cause malfunction or damage the parts.
6	Is electric wiring and pipeline installed correctly?	It may cause malfunction or damage the parts.
7	Is the unit grounded securely?	It may cause electric leakage.
8	Does the power cord follow the specification?	It may cause malfunction or damage the parts.
9	Is there any obstruction in air inlet and air outlet?	It may cause insufficient cooling (heating).
10	The dust and sundries caused during installation are removed?	It may cause malfunction or damaging the parts.
11	The gas valve and liquid valve of connection pipe are open completely?	It may cause insufficient cooling (heating) capacity.

2. Test Operation

- (1) Preparation of test operation
 - The client approves the air conditioner installation.
 - Specify the important notes for air conditioner to the client.
- (2) Method of test operation
 - Put through the power, press ON/OFF button on the remote controller to start operation.
 - Press MODE button to select AUTO, COOL, DRY, FAN and HEAT to check whether the operation is normal or not.
 - If the ambient temperature is lower than 16°C(61°F), the air conditioner can't start cooling.

8.9 Wired Controller

If the product you bought is equipped with wired controller, please refer to the following introductions of wired controller.

1. Displaying Part

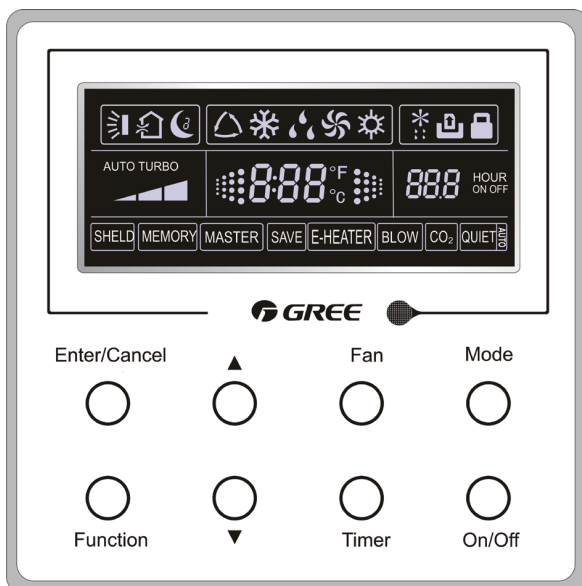

Fig1.1.1 Outline of wired controller

1.1 LCD Display of Wired Controller

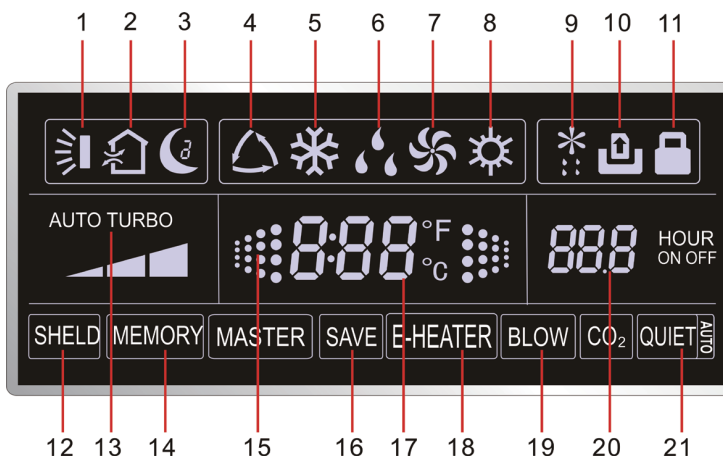

Fig.1.1.2 LCD display

1.2 Instruction to LCD Display

No.	Symbols	Description
1		Swing function
2		Air exchange function (this function is yet unavailable for this unit)
3		Sleep function (Only sleep 1)
4		Each kind of running mode of indoor unit (auto mode)
5		Cooling mode
6		Dry mode
7		Fan mode
8		Heating mode
9		Defrosting function for the outdoor unit
10		Gate-control function (this function is yet unavailable for this unit)

3 Operation Instructions

3.1 On/Off

Press On/Off to turn on the unit and turn it off by another press.

Note: The state shown in Fig.3.1.1 indicates the “Off” state of the unit after power on. The state shown in Fig.3.1.2 indicates the “On” state of the unit after power on.

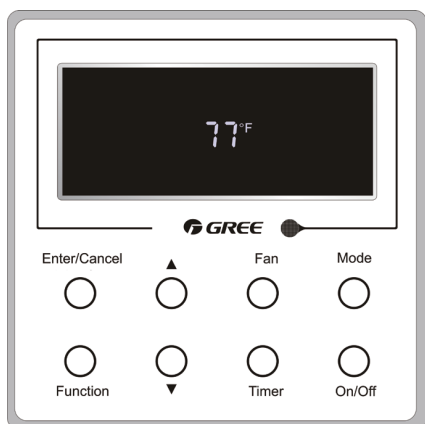

Fig.3.1.1 “Off” State

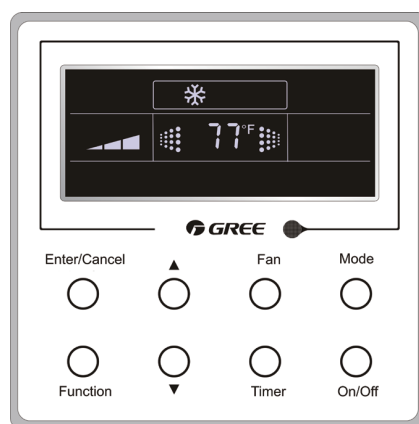
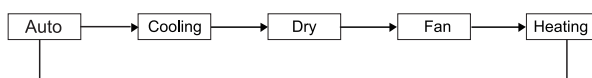

Fig.3.1.2 “On” State

3.2 Mode Setting

Under ON state of the unit, press the Mode to switch the operation modes as the following sequence: Auto–Cooling–Dry–Fan–Heating.



3.3 Temperature Setting

Press ▲ or ▼ to increase/decrease the preset temperature. If pressing either of them continuously, the temperature will be increased or decreased by 1°C every 0.5s, as shown in Fig.3.3.1.

In the Cooling, Dry, Fan or Heating mode, the temperature setting range is 16~30°C(61~86°F).

In the Auto mode, the setting temperature is unadjustable.

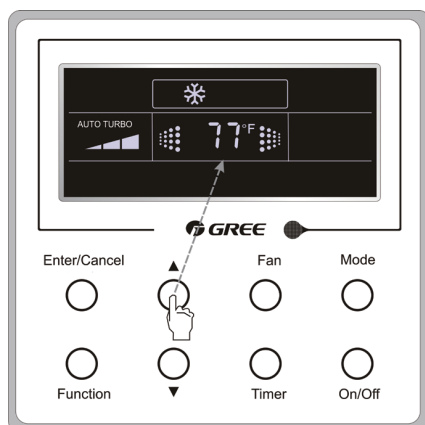

Fig.3.3.1

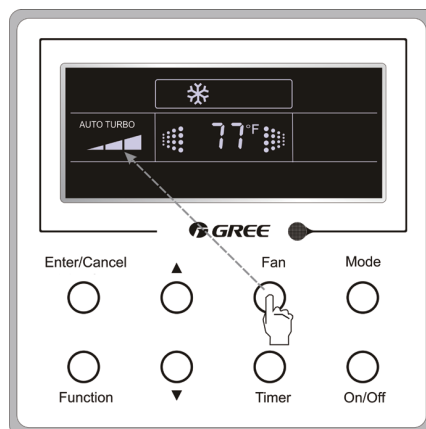
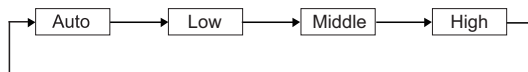

Fig.3.4.1

3.4 Fan Setting

Under the “On” state of the unit, press Fan and then fan speed of the indoor unit will change circularly as shown in Fig.3.4.1.



3.5 Timer Setting

Under on-state of the unit, Press Timer button to set timer off of the unit. Under off-state of the unit, press Timer button to set timer on of the unit in the same way.

• Timer on setting:

Under off-state of the unit without timer setting, if Timer button is pressed, LCD will display xx.Hour, with ON blinking. In this case, press ▲ or ▼ button to adjust timer on and then press Timer to confirm.

• Timer off setting:

Under on-state of the unit without timer setting, if Timer button is pressed, LCD will display xx. Hour,with OFF blinking. In this case, press▲ or ▼ button to adjust timer on and then press Timer to confirm.

• Cancel timer:

After setting of timer, if Timer button is pressed, LCD won't display xx. Hour so that timer setting is canceled.

Timer off setting under the “On” state of the unit is shown as Fig.3.5.1.

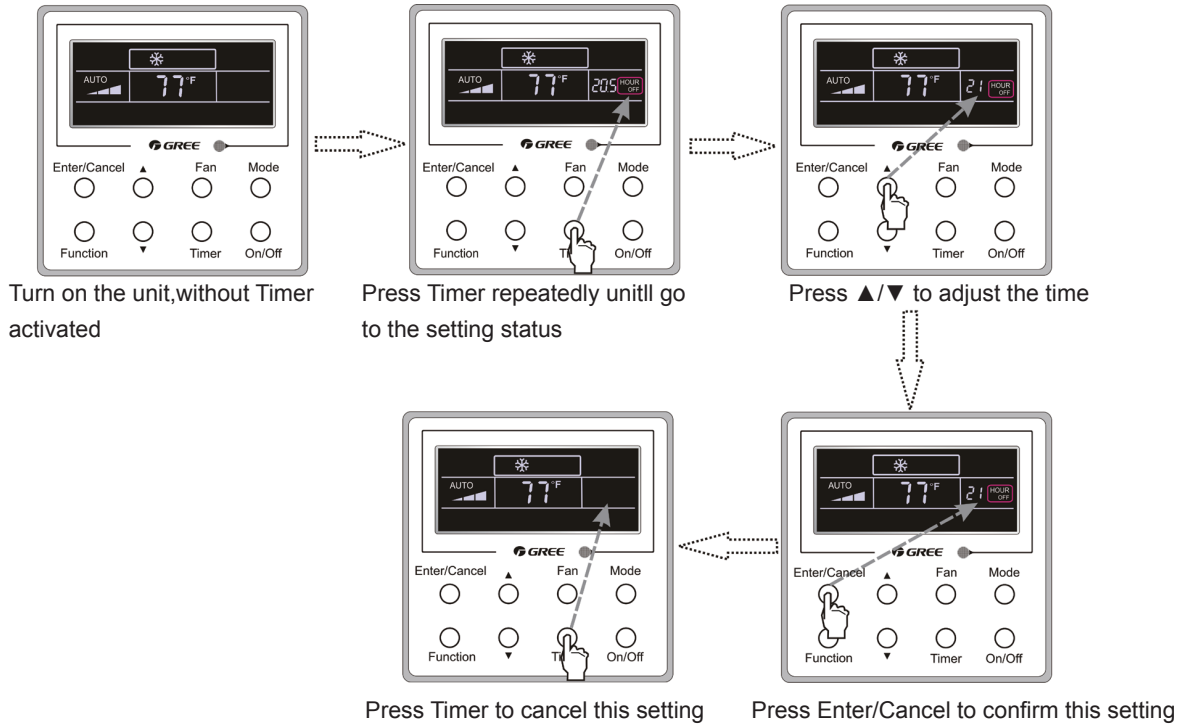

Fig.3.5.1 Timer off Setting under the “On” State of the Unit

Timer on setting under the “Off” state of the unit is shown as Fig.3.5.2.

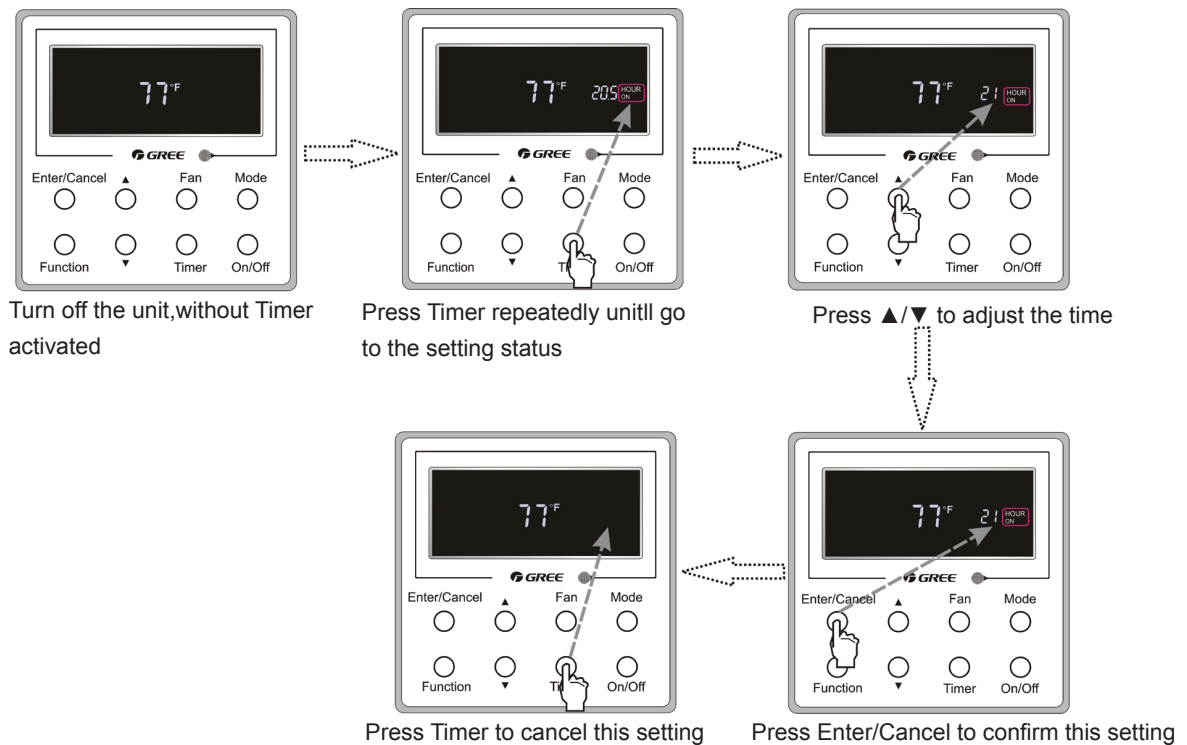



Fig.3.5.2 Timer on Setting under the “Off” State of the Unit

Timer range: 0.5-24hr. Every press of ▲ or ▼ will make the set time increased or decreased by 0.5hr. If either of them is pressed continuously, the set time will increase/ decrease by 0.5hr every 0.5s.

3.6 Swing Setting

Swing On: Press Function under on state of the unit to activate the swing function. In this case,  will blink, After that, press Enter/Cancel to make a confirmation.

Swing Off: When the Swing function is on, press Function to enter the Swing setting interface, with  blinking. After that, press Enter/Cancel to cancel this function. Swing setting is shown as Fig.3.6.1.

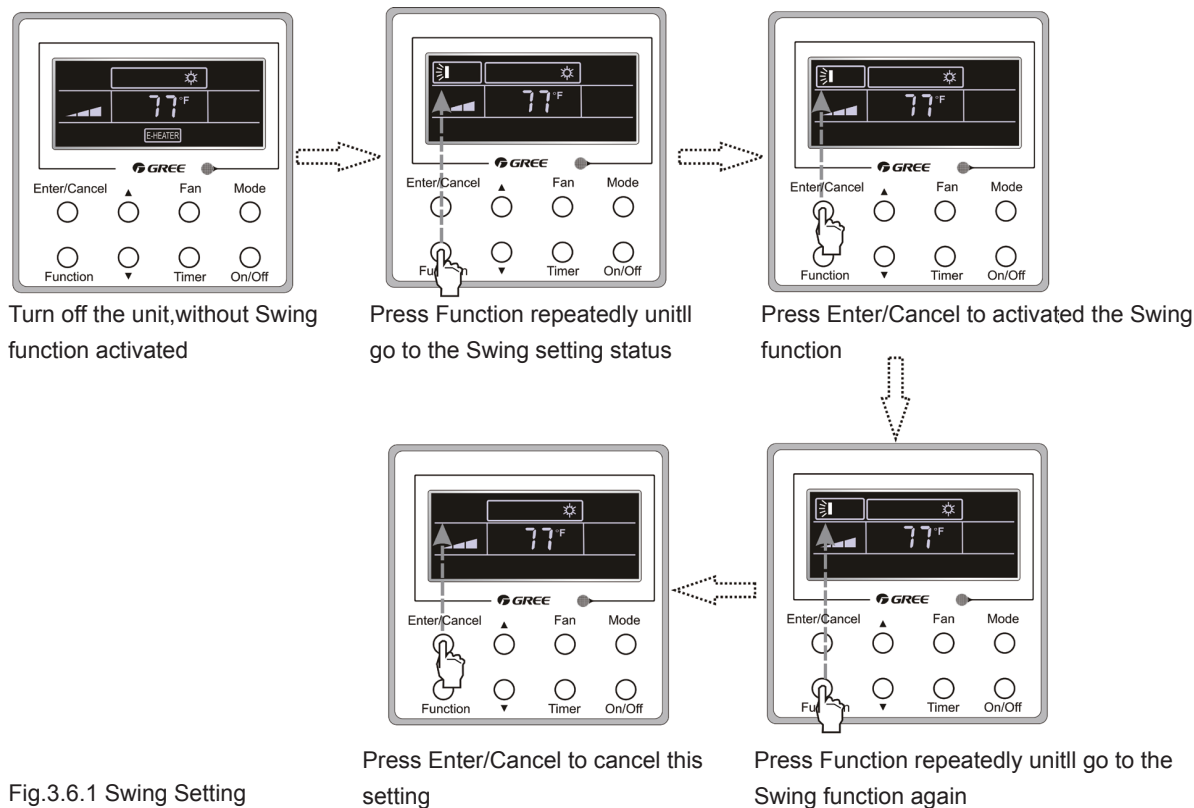

Fig.3.6.1 Swing Setting

Notes:

- (1) Sleep, Turbo or Blow setting is the same as the Swing setting.
- (2) After the setting has been done, it has to press the key “Enter/Cancel” to back to the setting status or quit automatically five seconds later.

3.7 Sleep Setting

Sleep on: Press Function under the On state of the unit till the unit enters the Sleep setting state. After that, press Enter/Cancel to confirm this setting.

Sleep off: When the Sleep function is activated, press Function to enter the Sleep setting status. After that, press Enter/Cancel to cancel this function.

In the Cooling or Dry mode, the temperature will increase by 1°C(1~2°F) after the unit runs under Sleep1 for 1hr and 1°C(1~2°F) after another 1hr. After that, the unit will run at this temperature.

In the Heating mode, the temperature will decrease by 1°C(1~2°F) after the unit runs under Sleep 1 for 1hr and 1°C(1~2°F) after another 1hr. After that, the unit will run at this temperature.

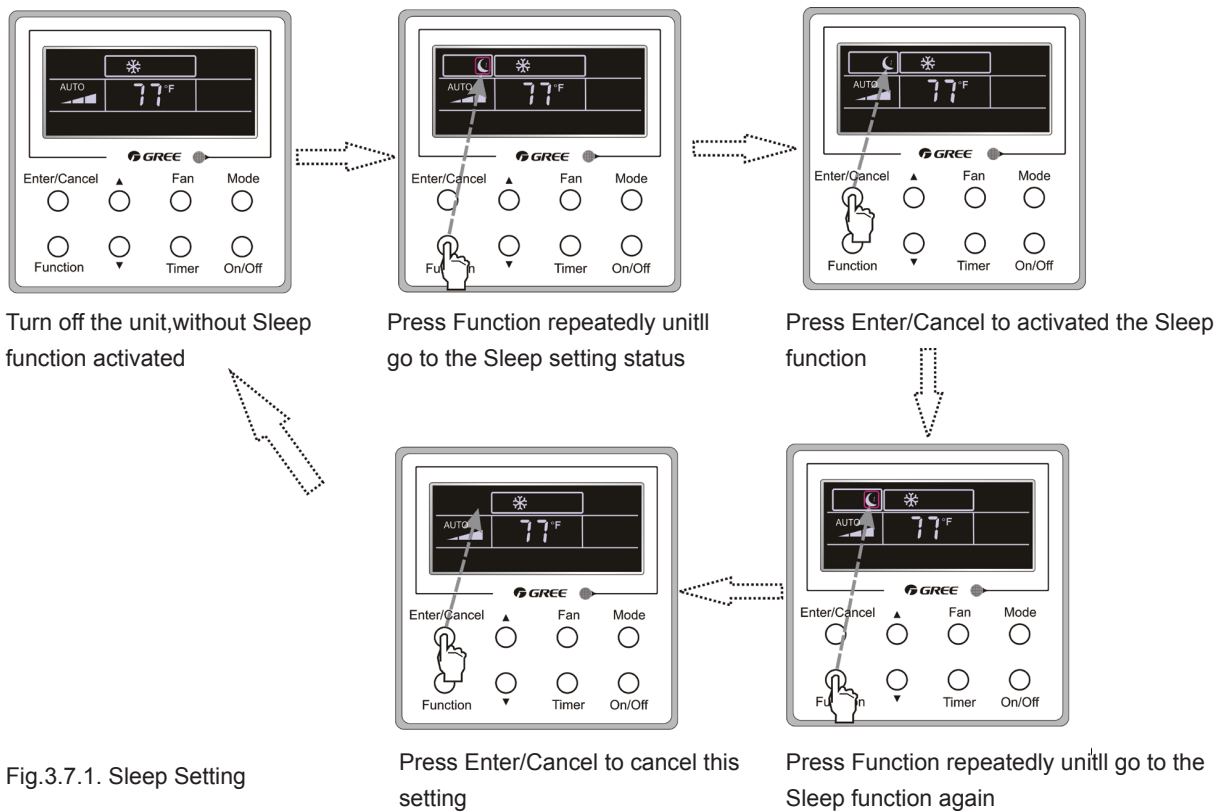

Fig.3.7.1. Sleep Setting

3.8 Turbo Setting

Turbo function: The unit at the high fan speed can realize quick cooling or heating so that the room temperature can quickly approach the setting value.

In the Cooling or Heating mode, press Function till the unit enters the Turbo setting status and then press Enter/Cancel to confirm the setting.

When the Turbo function is activated, press Function to enter the Turbo setting status and then press Enter/Cancel to cancel this function.

Turbo function setting is as shown in Fig.3.8.1.

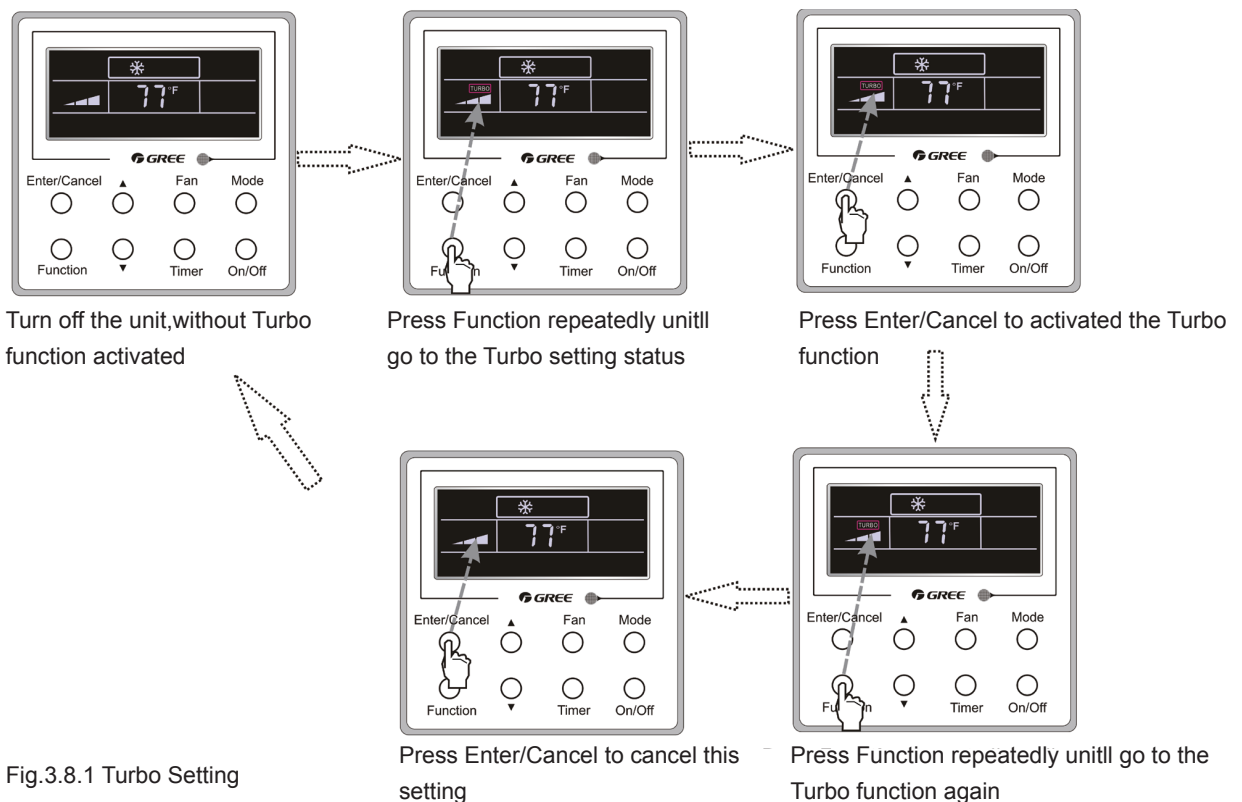

Fig.3.8.1 Turbo Setting

Notes:

(1)When the Blow function is activated, if turning off the unit by pressing On/Off or by the remote controller, the indoor fan will run at the low fan speed for 2 min, with “BLOW” displayed on the LCD. While, if the Blow function is deactivated, the indoor fan will be turned off directly.

(2)Blow function is unavailable in the Fan or Heating mode.

3.11 Other Functions

a. Lock

Upon startup of the unit without malfunction or under the “Off” state of the unit, press ▲ and ▼ at the same time for 5s till the wired controller enters the Lock function. In this case, LCD displays .

After that, repress these two buttons at the same time for 5s to quit this function.

Under the Lock state, any other button press won't get any response.

b. Memory

Memory switchover: Under the “Off” state of the unit, press Mode and ▲ at the same time for 5s to switch memory states between memory on and memory off. When this function is activated, Memory will be displayed. If this function is not set, the unit will be under the “Off” state after power failure and then power recovery.

Memory recovery: If this function has been set for the wired controller, the wired controller after power failure will resume its original running state upon power recovery. Memory contents: On/Off, Mode, set temperature, set fan speed and Lock function.

4. Installation and Dismantlement

4.1 Connection of the Signal Line of the Wired Controller

- Open the cover of the electric control box of the indoor unit.
- Let the single line of the wired controller through the rubber ring.
- Connect the signal line of the wired control to the 4-pin socket of the indoor unit PCB.
- Tighten the signal wire with ties.
- The communication distance between the main board and the wired controller can be up to 20 meters (the standard distance is 8 meters)

4.2 Installation of the Wired Controller

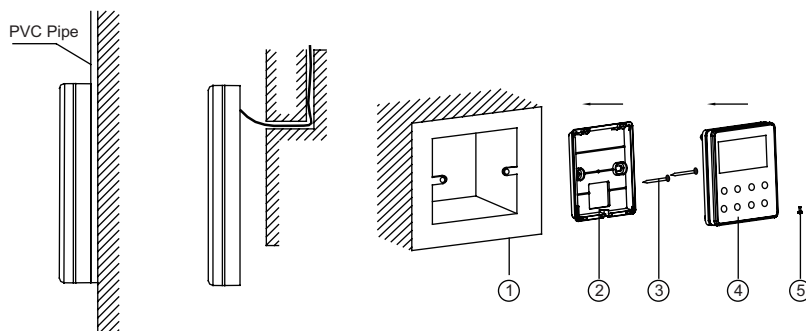

Fig.4.1 Accessories for the Installation of the Wired Controller

No.	1	2	3	4	5
Name	Socket box embedded in the wall	Soleplate of the Wired Controller	Screw M4X25	Front Panel of the Wired Controller	Screw ST 2.9X6

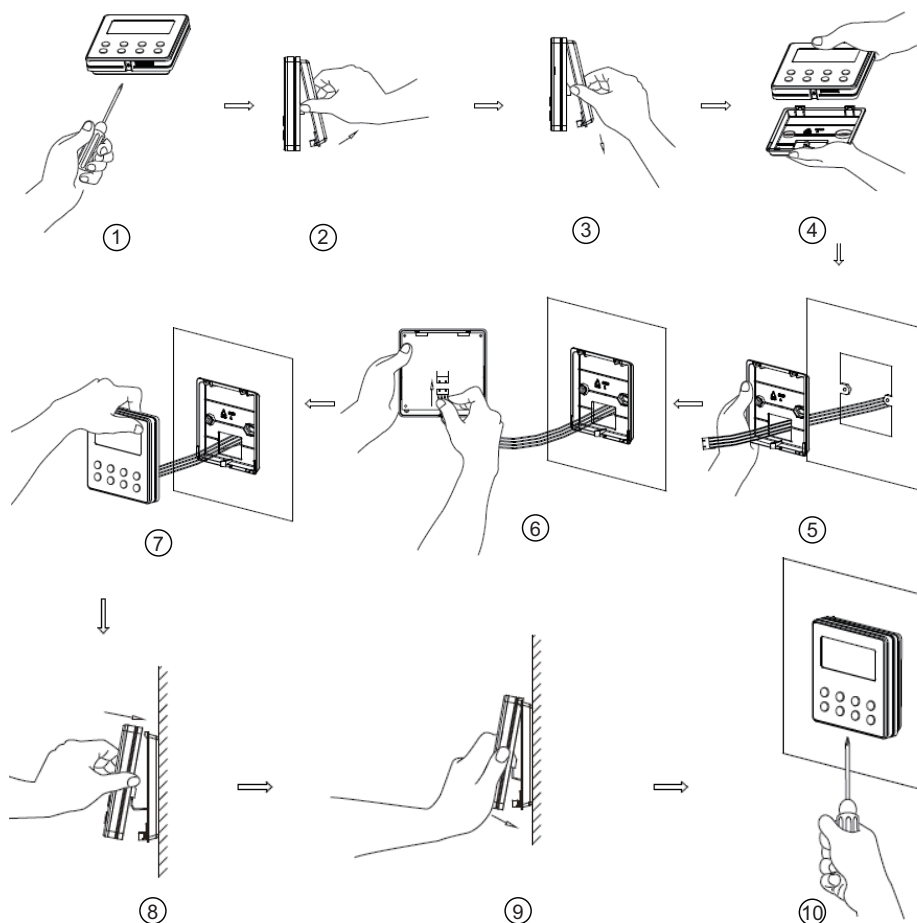

Fig.4.2

Fig.4.2 shows the installation steps of the wired controller, but there are some issues that need your attention.

- (1) Prior to the installation, please firstly cut off the power supply of the wire buried in the installation hole, that is, no operation is allowed with electricity during the whole installation.
- (2) Pull out the four-core twisted pair line from the installation holes and then let it go through the rectangular hole behind the soleplate of the wired controller.
- (3) Stick the soleplate of the wire controller to the wall over the installation hole and then fix it with screws M4X25.
- (4) Insert the four-core twisted pair line into the slot of the wired controller and then buckle the front panel and the soleplate of the wired controller together.
- (5) Finally, fix the front panel and the soleplate of the wired controller tightly by screws ST2.9X6.

⚠ CAUTION!

Please pay special attention to the followings during the connection to avoid the malfunction of the air conditioning unit due to electromagnetic interference.

- (1) Separate the signal and communication lines of the wired controller from the power cord and connection lines between the indoor and outdoor unit, with a minimum interval of 20cm, otherwise the communication of the unit will probably work abnormally.
- (2) If the air conditioning unit is installed where is vulnerable to electromagnetic interference, then the signal and communication lines of the wired controller must be the shielding twisted pair lines.

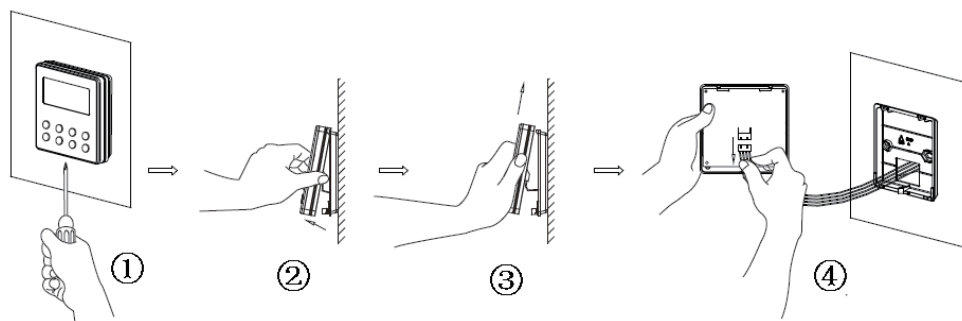

5 Errors Display

If there is an error occurring during the operation of the system, the error code will be displayed on the LCD, as show in Fig.5.1. If multi errors occur at the same time, their codes will be displayed circularly.

Note: In event of any error, please turn off the unit and contact the professionally skilled personnel.

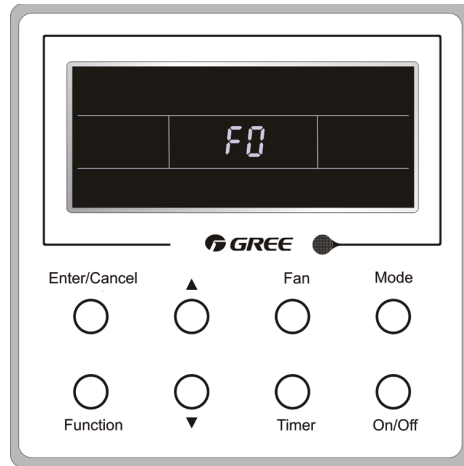

Fig.5.1

9. Maintenance

9.1 Error Code List

NO.	Malfunction Name	Display Method of Indoor Unit			Display Method of Outdoor Unit			A/C status	Possible Causes	
		Dual-8 Code Display	Indicator Display (during blinking, ON 0.5s and OFF 0.5s)			Indicator has 3 kinds of display status and during blinking, ON 0.5s and OFF 0.5s				
			Operation Indicator	Cool Indicator	Heating Indicator	Yellow Indicator	Red Indicator			Green Indicator
1	High pressure protection of system	E1							During cooling and drying operation, except indoor fan operates, all loads stop operation. During heating operation, the complete unit stops.	Possible reasons: 1. Refrigerant was superabundant; 2. Poor heat exchange (including filth blockage of heat exchanger and bad radiating environment); Ambient temperature is too high.
2	Antifreezing protection	E2				OFF 1S and blink 3 times			During cooling and drying operation, compressor and outdoor fan stop while indoor fan operates.	1. Poor air-return in indoor unit; 2. Fan speed is abnormal; 3. Evaporator is dirty.
3	Refrigerant leakage protection	F0					OFF 1S and blink 9 times		The Dual-8 Code Display will show F0 and the complete unit stops.	1.Refrigerant leakage; 2.Indoor evaporator temperature sensor works abnormally; 3.The unit has been plugged up somewhere.
4	High discharge temperature protection of compressor	E4				OFF 1S and blink 7 times			During cooling and drying operation, compressor and outdoor fan stop while indoor fan operates. During heating operation, all loads stop.	Please refer to the malfunction analysis (discharge protection, overload).
5	Overcurrent protection	E5				OFF 1S and blink 5 times			During cooling and drying operation, compressor and outdoor fan stop while indoor fan operates. During heating operation, all loads stop.	1. Supply voltage is unstable; 2. Supply voltage is too low and load is too high; 3. Evaporator is dirty.
6	Communication Malfunction	E6				Always			During cooling operation, compressor stops while indoor fan motor operates. During heating operation, the complete unit stops.	Refer to the corresponding malfunction analysis.
7	High temperature resistant protection	E8				OFF 1S and blink 6 times			During cooling operation: compressor will stop while indoor fan will operate. During heating operation, the complete unit stops.	Refer to the malfunction analysis (overload, high temperature resistant).
8	EEPROM malfunction	EE				OFF 1S and blink 11 times			During cooling and drying operation, compressor will stop while indoor fan will operate; During heating operation, the complete unit will stop	Replace outdoor control panel AP1
9	Limit/ decrease frequency due to high temperature of module	EU							All loads operate normally, while operation frequency for compressor is decreased	Discharging after the complete unit is de-energized for 20mins, check whether the thermal grease on IPM Module of outdoor control panel AP1 is sufficient and whether the radiator is inserted tightly. If its no use, please replace control panel AP1.
10	Malfunction protection of jumper cap	C5							Wireless remote receiver and button are effective, but can not dispose the related command	1. No jumper cap insert on mainboard. 2. Incorrect insert of jumper cap. 3. Jumper cap damaged. 4. Abnormal detecting circuit of mainboard.

NO.	Malfunction Name	Display Method of Indoor Unit				Display Method of Outdoor Unit			A/C status	Possible Causes
		Dual-8 Code Display	Indicator Display (during blinking, ON 0.5s and OFF 0.5s)			Indicator has 3 kinds of display status and during blinking, ON 0.5s and OFF 0.5s				
			Operation Indicator	Cool Indicator	Heating Indicator	Yellow Indicator	Red Indicator	Green Indicator		
11	Gathering refrigerant	Fo				OFF 1S and blink 17 times			When the outdoor unit receive signal of Gathering refrigerant ,the system will be forced to run under cooling mode for gathering refrigerant	Nominal cooling mode
12	Indoor ambient temperature sensor is open/short circuited	F1							During cooling and drying operation, indoor unit operates while other loads will stop; during heating operation, the complete unit will stop operation.	<ol style="list-style-type: none"> 1. Loosening or bad contact of indoor ambient temp. sensor and mainboard terminal. 2. Components in mainboard fell down leads short circuit. 3. Indoor ambient temp. sensor damaged.(check with sensor resistance value chart) 4. Mainboard damaged.
13	Indoor evaporator temperature sensor is open/short circuited	F2							AC stops operation once reaches the setting temperature. Cooling, drying: internal fan motor stops operation while other loads stop operation; heating: AC stop operation	<ol style="list-style-type: none"> 1. Loosening or bad contact of Indoor evaporator temp. sensor and mainboard terminal. 2. Components on the mainboard fall down leads short circuit. 3. Indoor evaporator temp. sensor damaged.(check temp. sensor value chart for testing) 4. Mainboard damaged.
14	Outdoor ambient temperature sensor is open/short circuited	F3					OFF 1S and blink 6 times		During cooling and drying operating, compressor stops while indoor fan operates; During heating operation, the complete unit will stop operation	Outdoor temperature sensor hasnt been connected well or is damaged. Please check it by referring to the resistance table for temperature sensor)
15	Outdoor condenser temperature sensor is open/short circuited	F4					OFF 1S and blink 5 times		During cooling and drying operation, compressor stops while indoor fan will operate; During heating operation, the complete unit will stop operation.	Outdoor temperature sensor hasnt been connected well or is damaged. Please check it by referring to the resistance table for temperature sensor)
16	Outdoor discharge temperature sensor is open/short circuited	F5					OFF 1S and blink 7 times		During cooling and drying operation, compressor will sop after operating for about 3 mins, while indoor fan will operate; During heating operation, the complete unit will stop after operating for about 3 mins.	<ol style="list-style-type: none"> 1.Outdoor temperature sensor hasnt been connected well or is damaged. Please check it by referring to the resistance table for temperature sensor) 2.The head of temperature sensor hasnt been inserted into the copper tube
17	Limit/ decrease frequency due to overload	F6					OFF 1S and blink 3 times		All loads operate normally, while operation frequency for compressor is decreased	Refer to the malfunction analysis (overload, high temperature resistant)
18	Decrease frequency due to overcurrent	F8					OFF 1S and blink once		All loads operate normally, while operation frequency for compressor is decreased	The input supply voltage is too low; System pressure is too high and overload

NO.	Malfunction Name	Display Method of Indoor Unit			Display Method of Outdoor Unit			A/C status	Possible Causes	
		Dual-8 Code Display	Indicator Display (during blinking, ON 0.5s and OFF 0.5s)			Indicator has 3 kinds of display status and during blinking, ON 0.5s and OFF 0.5s				
			Operation Indicator	Cool Indicator	Heating Indicator	Yellow Indicator	Red Indicator			Green Indicator
19	Decrease frequency due to high air discharge	F9					OFF 1S and blink twice	All loads operate normally, while operation frequency for compressor is decreased	Overload or temperature is too high; Refrigerant is insufficient; Malfunction of electric expansion valve (EKV)	
20	Limit/ decrease frequency due to antifreezing	FH					OFF 1S and blink 4 times	All loads operate normally, while operation frequency for compressor is decreased	Poor air-return in indoor unit or fan speed is too low	
21	Voltage for DC bus-bar is too high	PH					OFF 1S and blink 13 times	During cooling and drying operation, compressor will stop while indoor fan will operate; During heating operation, the complete unit will stop operation.	1. Measure the voltage of position L and N on wiring board (XT), if the voltage is higher than 265VAC, turn on the unit after the supply voltage is increased to the normal range. 2.If the AC input is normal, measure the voltage of electrolytic capacitor C on control panel (AP1), if its normal, theres malfunction for the circuit, please replace the control panel (AP1)	
22	Voltage of DC bus-bar is too low	PL					OFF 1S and blink 12 times	During cooling and drying operation, compressor will stop while indoor fan will operate; During heating operation, the complete unit will stop	1. Measure the voltage of position L and N on wiring board (XT), if the voltage is higher than 150VAC, turn on the unit after the supply voltage is increased to the normal range. 2.If the AC input is normal, measure the voltage of electrolytic capacitor C on control panel (AP1), if its normal, theres malfunction for the circuit, please replace the control panel (AP1)	
23	Compressor Min frequency in test state	P0							Showing during min. cooling or min. heating test	
24	Compresso r rated frequenc e in test state	P1							Showing during nominal cooling or nominal heating test	
25	Compressor maximum frequency in test state	P2							Showing during max. cooling or max. heating test	

NO.	Malfunction Name	Display Method of Indoor Unit			Display Method of Outdoor Unit			A/C status	Possible Causes	
		Dual-8 Code Display	Indicator Display (during blinking, ON 0.5s and OFF 0.5s)			Indicator has 3 kinds of display status and during blinking, ON 0.5s and OFF 0.5s				
			Operation Indicator	Cool Indicator	Heating Indicator	Yellow Indicator	Red Indicator			Green Indicator
26	Compressor intermediate frequency in test state	P3							Showing during middle cooling or middle heating test	
27	Overcurrent protection of phase current for compressor	P5						During cooling and drying operation, compressor will stop while indoor fan will operate; During heating operation, the complete unit will stop operation.	Refer to the malfunction analysis (IPM protection, loss of synchronism protection and overcurrent protection of phase current for compressor).	
28	Charging malfunction of capacitor	PU						During cooling and drying operation, compressor will stop while indoor fan will operate; During heating operation, the complete unit will stop	Refer to the part three—charging malfunction analysis of capacitor	
29	Malfunction of module temperature sensor circuit	P7						During cooling and drying operation, compressor will stop while indoor fan will operate; During heating operation, the complete unit will stop	Replace outdoor control panel AP1	
30	Module high temperature protection	P8						During cooling operation, compressor will stop while indoor fan will operate; During heating operation, the complete unit will stop	After the complete unit is de-energized for 20mins, check whether the thermal grease on IPM Module of outdoor control panel AP1 is sufficient and whether the radiator is inserted tightly. If its no use, please replace control panel AP1.	
31	Decrease frequency due to high temperature resistant during heating operation	H0						All loads operate normally, while operation frequency for compressor is decreased	Refer to the malfunction analysis (overload, high temperature resistant)	
32	Static dedusting protection	H2								
33	Overload protection for compressor	H3				OFF 1S and blink 8 times		During cooling and drying operation, compressor will stop while indoor fan will operate; During heating operation, the complete unit will stop operation.	1. Wiring terminal OVC-COMP is loosened. In normal state, the resistance for this terminal should be less than 1ohm. 2.Refer to the malfunction analysis (discharge protection, overload)	

NO.	Malfunction Name	Display Method of Indoor Unit			Display Method of Outdoor Unit			A/C status	Possible Causes	
		Dual-8 Code Display	Indicator Display (during blinking, ON 0.5s and OFF 0.5s)			Indicator has 3 kinds of display status and during blinking, ON 0.5s and OFF 0.5s				
			Operation Indicator	Cool Indicator	Heating Indicator	Yellow Indicator	Red Indicator			Green Indicator
34	System is abnormal	H4				OFF 1S and blink 6 times			During cooling and drying operation, compressor will stop while indoor fan will operate; During heating operation, the complete unit will stop operation.	Refer to the malfunction analysis (overload, high temperature resistant)
35	IPM protection	H5				OFF 1S and blink 4 times			During cooling and drying operation, compressor will stop while indoor fan will operate; During heating operation, the complete unit will stop operation.	Refer to the malfunction analysis (IPM protection, loss of synchronism protection and overcurrent protection of phase current for compressor.
36	Module temperature is too high	H5				OFF 1S and blink 10 times				
37	Internal motor (fan motor) do not operate	H6							Internal fan motor, external fan motor, compressor and electric heater stop operation,guide louver stops at present location.	1. Bad contact of DC motor feedback terminal. 2. Bad contact of DC motor control end. 3. Fan motor is stalling. 4. Motor malfunction. 5. Malfunction of mainboard rev detecting circuit.
38	Desynchronizing of compressor	H7							During cooling and drying operation, compressor will stop while indoor fan will operate; During heating operation, the complete unit will stop operation.	Refer to the malfunction analysis (IPM protection, loss of synchronism protection and overcurrent protection of phase current for compressor.
39	PFC protection	HC				OFF 1S and blink 14 times			During cooling and drying operation, compressor will stop while indoor fan will operate; During heating operation, the complete unit will stop operation.	Refer to the malfunction analysis
40	Outdoor DC fan motor malfunction	L3					OFF 1S and blink 14 times		Outdoor DC fan motor malfunction lead to compressor stop operation,	DC fan motor malfunction or system blocked or the connector loosed
41	power protection	L9				OFF 1S and blink 9 times			compressor stop operation and Outdoor fan motor will stop 30s latter , 3 minutes latter fan motor and compressor will restart	To protect the electronical components when detect high power
42	Indoor unit and outdoor unit doesn't match	LP				OFF 1S and blink 16 times			compressor and Outdoor fan motor can't work	Indoor unit and outdoor unit doesn't match
43	Failure start-up	LC							During cooling and drying operation, compressor will stop while indoor fan will operate; During heating operation, the complete unit will stop operation.	Refer to the malfunction analysis

NO.	Malfunction Name	Display Method of Indoor Unit			Display Method of Outdoor Unit			A/C status	Possible Causes	
		Dual-8 Code Display	Indicator Display (during blinking, ON 0.5s and OFF 0.5s)			Indicator has 3 kinds of display status and during blinking, ON 0.5s and OFF 0.5s				
			Operation Indicator	Cool Indicator	Heating Indicator	Yellow Indicator	Red Indicator			Green Indicator
44	Malfunction of phase current detection circuit for compressor	U1							During cooling and drying operation, compressor will stop while indoor fan will operate; During heating operation, the complete unit will stop	Replace outdoor control panel AP1
45	Malfunction of voltage dropping for DC bus-bar	U3							During cooling and drying operation, compressor will stop while indoor fan will operate; During heating operation, the complete unit will stop	Supply voltage is unstable
46	Malfunction of complete units current detection	U5							During cooling and drying operation, the compressor will stop while indoor fan will operate; During heating operating, the complete unit will stop operation.	Theres circuit malfunction on outdoor units control panel AP1, please replace the outdoor units control panel AP1.
47	The four-way valve is abnormal	U7							If this malfunction occurs during heating operation, the complete unit will stop operation.	1. Supply voltage is lower than AC175V; 2. Wiring terminal 4V is loosened or broken; 3. 4V is damaged, please replace 4V.
48	Zero-crossing malfunction of outdoor unit	U9							During cooling operation, compressor will stop while indoor fan will operate; during heating, the complete unit will stop operation.	Replace outdoor control panel AP1
49	Frequency limiting (power)						OFF 1S and blink 13 times			
50	Compressor running					OFF 1S and blink once				
51	The temperature for turning on the unit is reached						OFF 1S and blink 8 times			
52	Frequency limiting (module temperature)						OFF 1S and blink 11 times			

NO.	Malfunction Name	Display Method of Indoor Unit			Display Method of Outdoor Unit			A/C status	Possible Causes
		Dual-8 Code Display	Indicator Display (during blinking, ON 0.5s and OFF 0.5s)			Indicator has 3 kinds of display status and during blinking, ON 0.5s and OFF 0.5s			
			Operation Indicator	Cool Indicator	Heating Indicator	Yellow Indicator	Red Indicator	Green Indicator	
53	Normal communication							OFF 0.5S and blink once	
54	Defrosting		OFF 3S and blink once (during blinking, ON 10s and OFF 0.5s)			OFF 1S and blink twice			Defrosting will occur in heating mode. Compressor will operate while indoor fan will stop operation.
55	U8								The complete unit stops
56	Malfunction of detecting plate(WIFI)	JF							1.Power supply is abnormal; 2.Detection circuit of indoor control mainboard is abnormal.

2. Malfunction of Blocked Protection of IDU Fan Motor H6

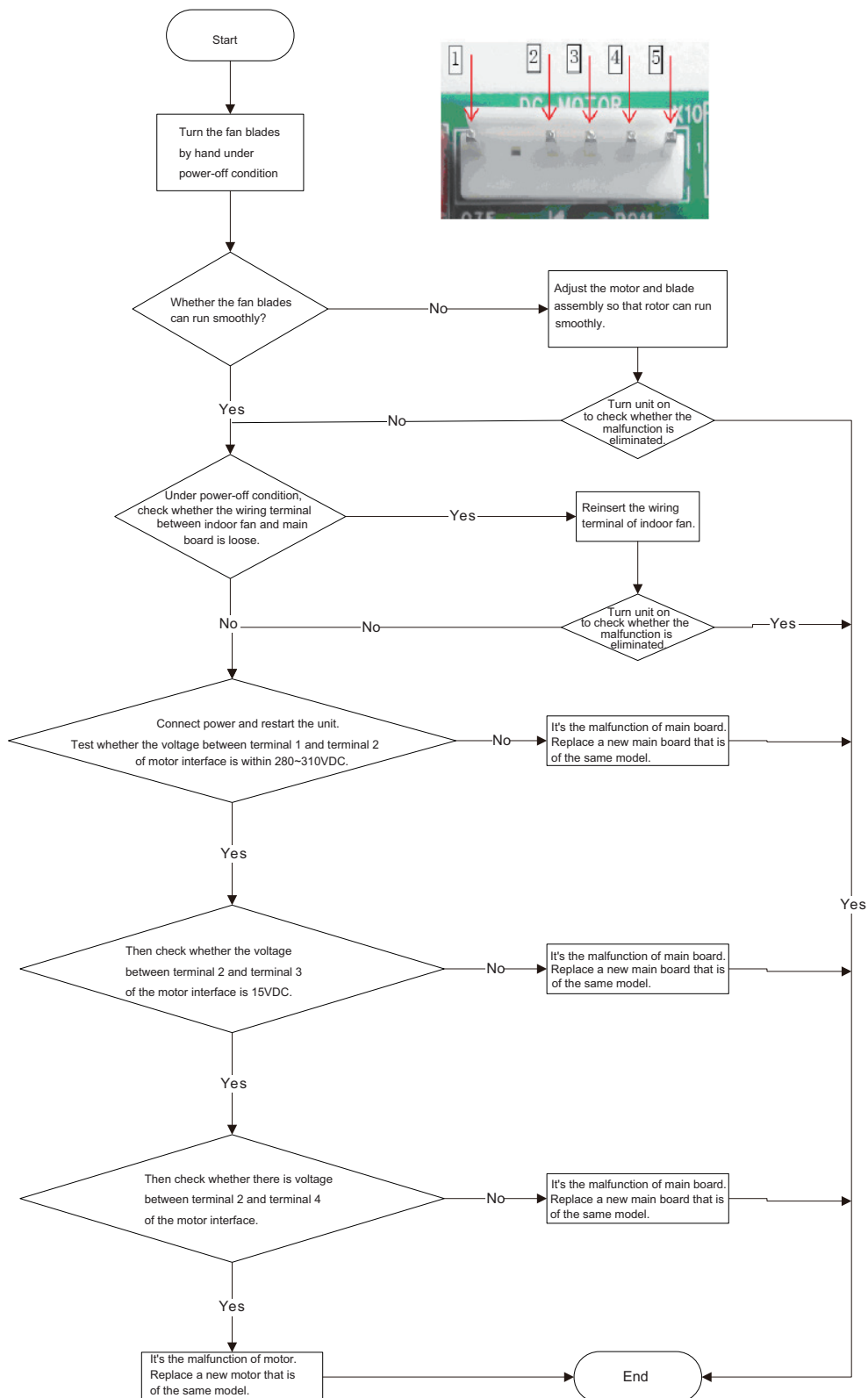

3. Malfunction of Protection of Jumper Cap C5

Main detection points:

- Is there jumper cap on the mainboard?
- Is the jumper cap inserted correctly and tightly?
- The jumper is broken?
- The motor is broken?
- Detection circuit of the mainboard is defined abnormal?

Malfunction diagnosis process:

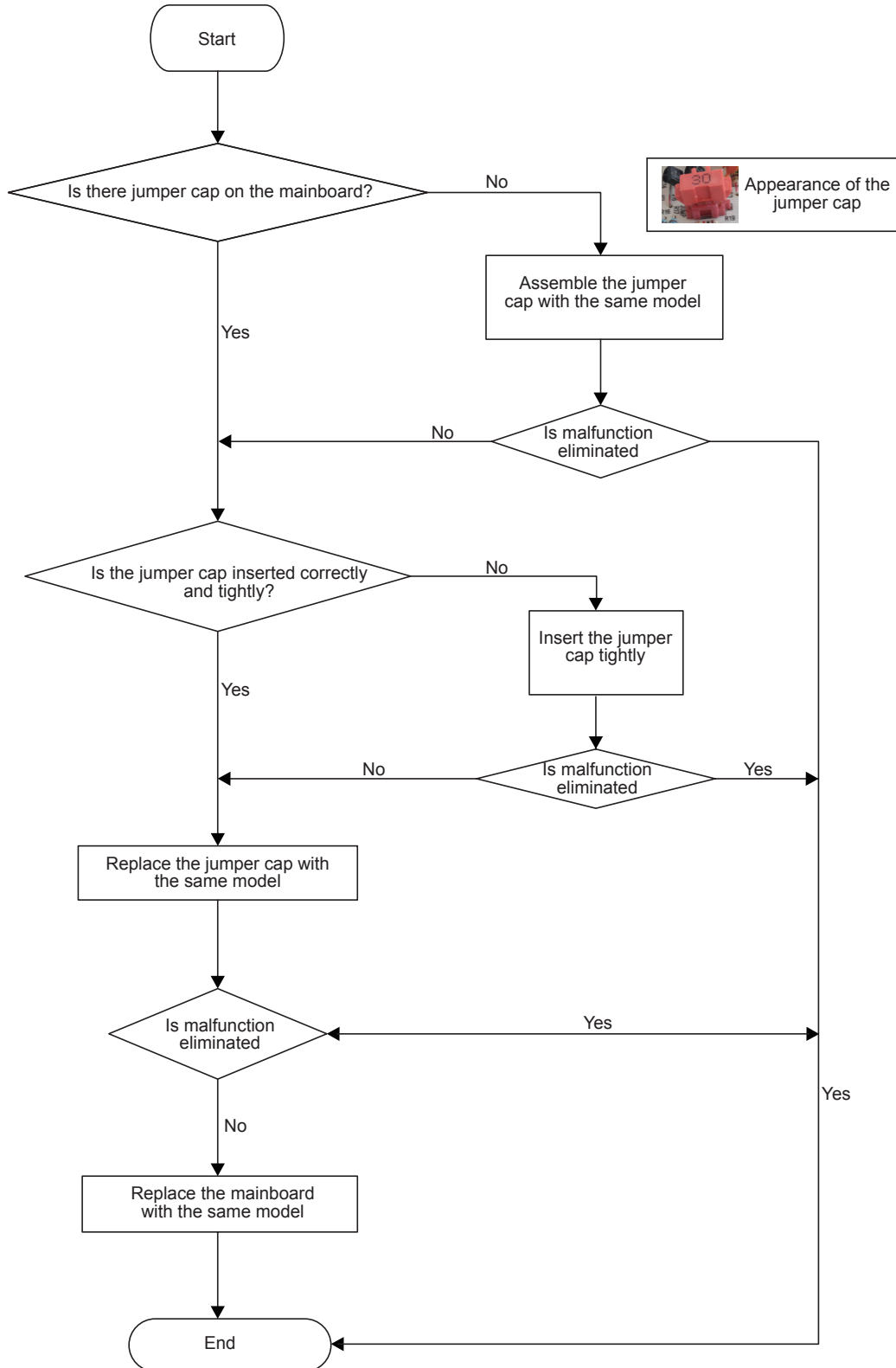

4. Malfunction of Overcurrent Protection E5

Main detection points:

- Is the supply voltage unstable with big fluctuation?
- Is the supply voltage too low with overload?
- Hardware trouble?

Malfunction diagnosis process:

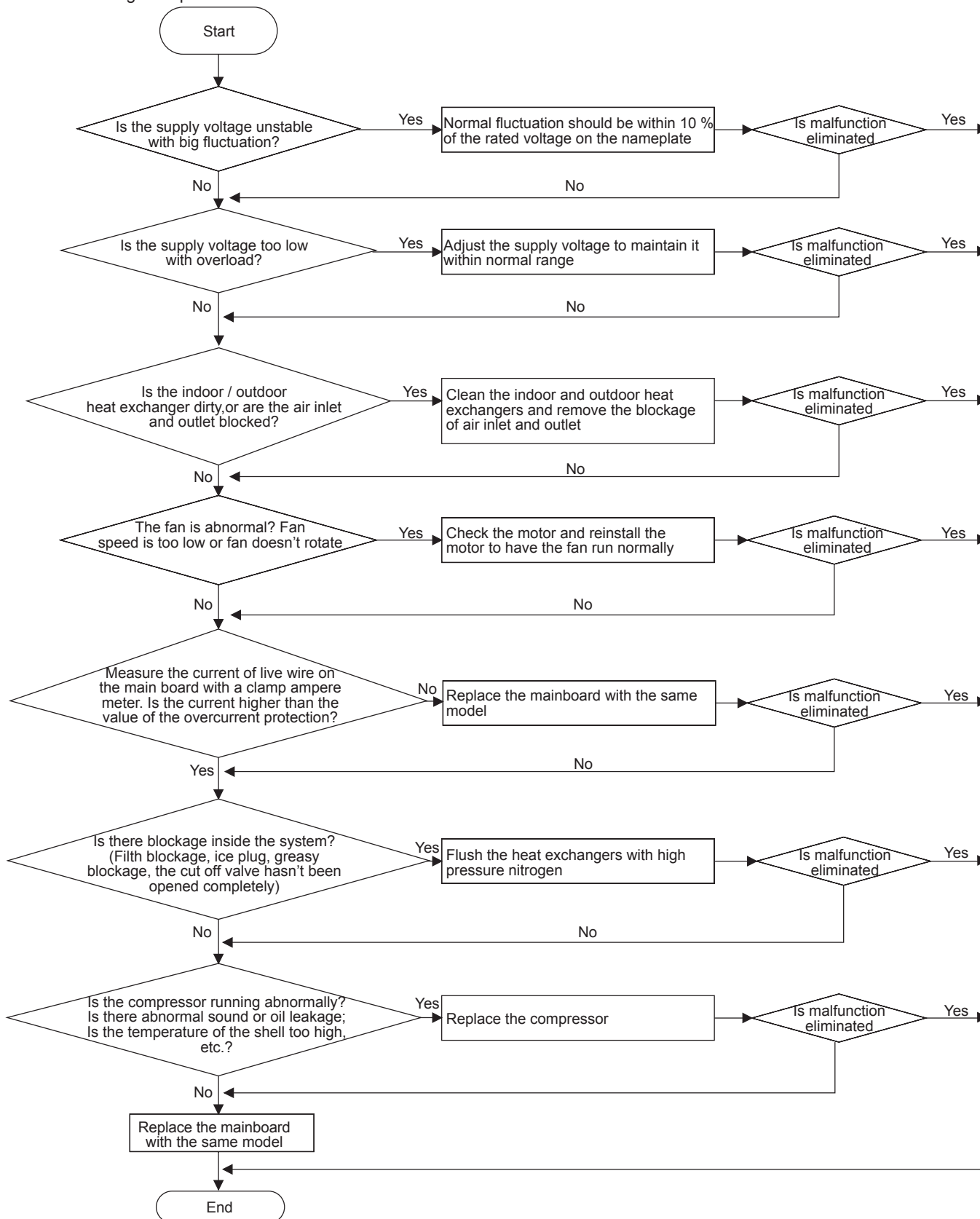

5. Communication Malfunction E6

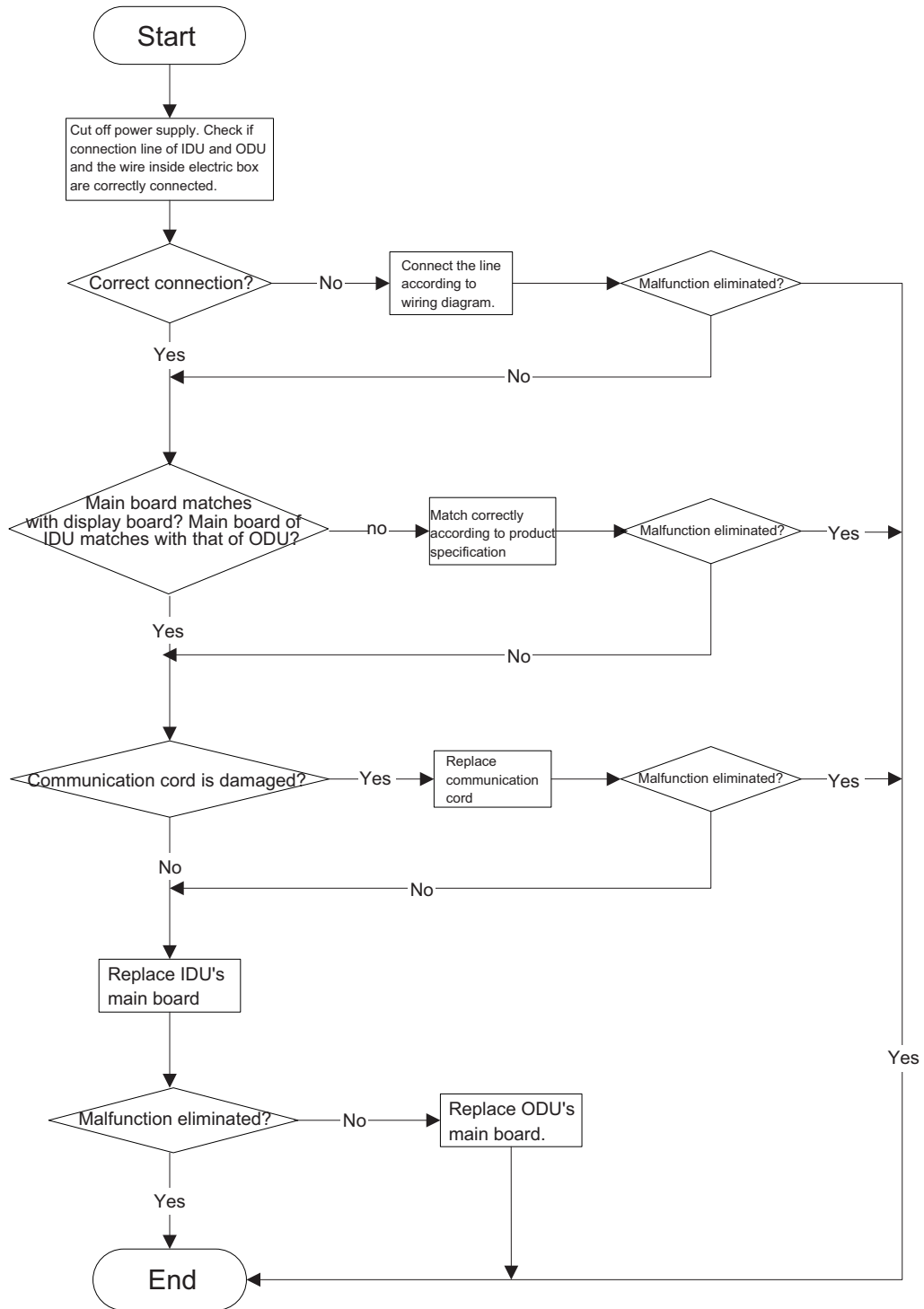

6. Malfunction of detecting plate(WIFI) JF

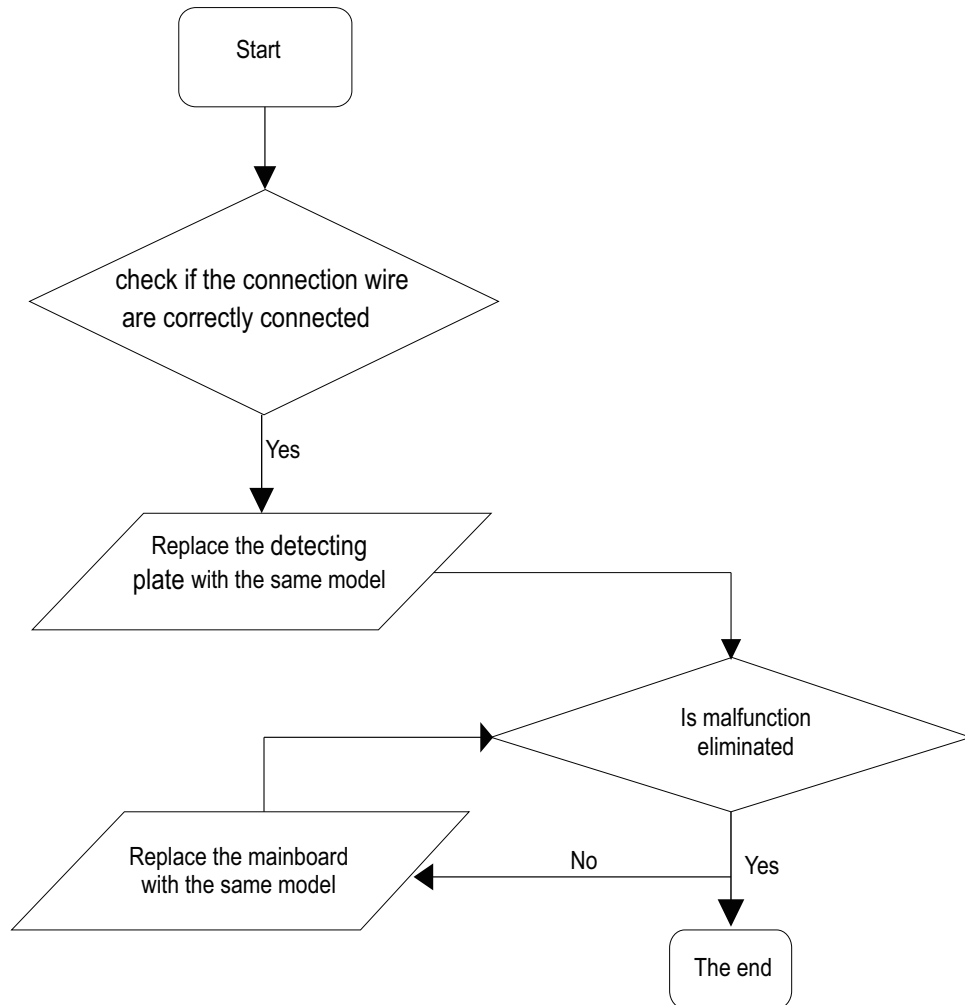

Outdoor Unit

1. Capacity charging malfunction (outdoor unit malfunction) (AP1 below means control board of outdoor unit)

Main detection points:

- Detect if the voltage of L and N terminal of XT wiring board is between 210VAC-240VAC by alternating voltage meter;
- Is reactor (L) well connected? Is connection wire loosened or pulled out? Is reactor (L) damaged?

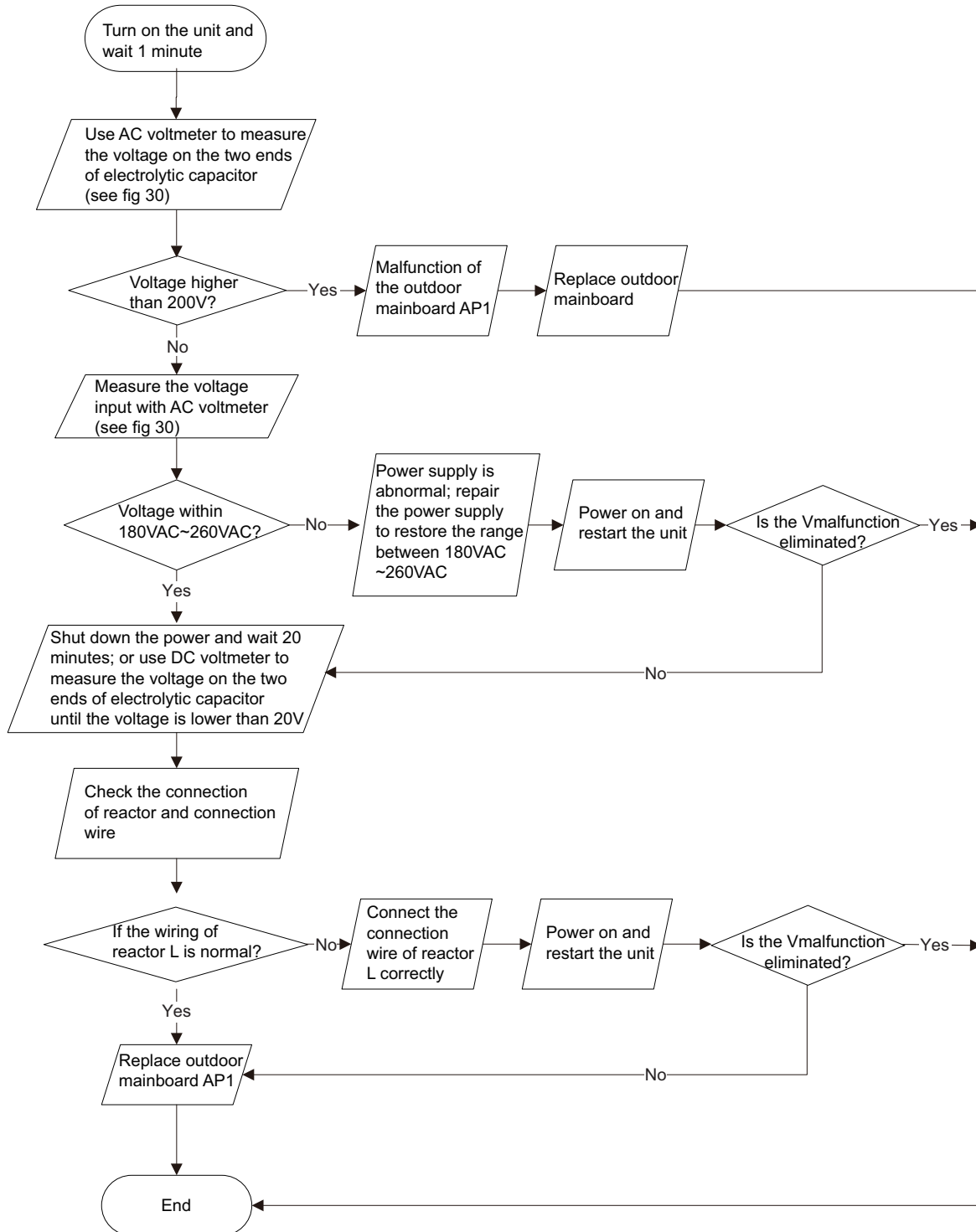

2. IPM protection(H5), desynchronizing malfunction(H7), overcurrent of compressor phase current (P5) (AP1 below means control board of outdoor unit)

Main detection points:

- Is voltage input within the normal range
- If the control board AP1 is well connected with compressor COMP? If they are loosened? If the connection sequence is correct?
- Heat exchange of unit is not good (heat exchanger is dirty and unit radiating environment is bad);
- If the system pressure is too high?
- If the refrigerant charging amount is appropriate?
- If coil resistance of compressor is normal? Is compressor coil insulating to copper pipe well?
- If the work load of unit is heavy? If radiating of unit is good?

Malfunction diagnosis process:

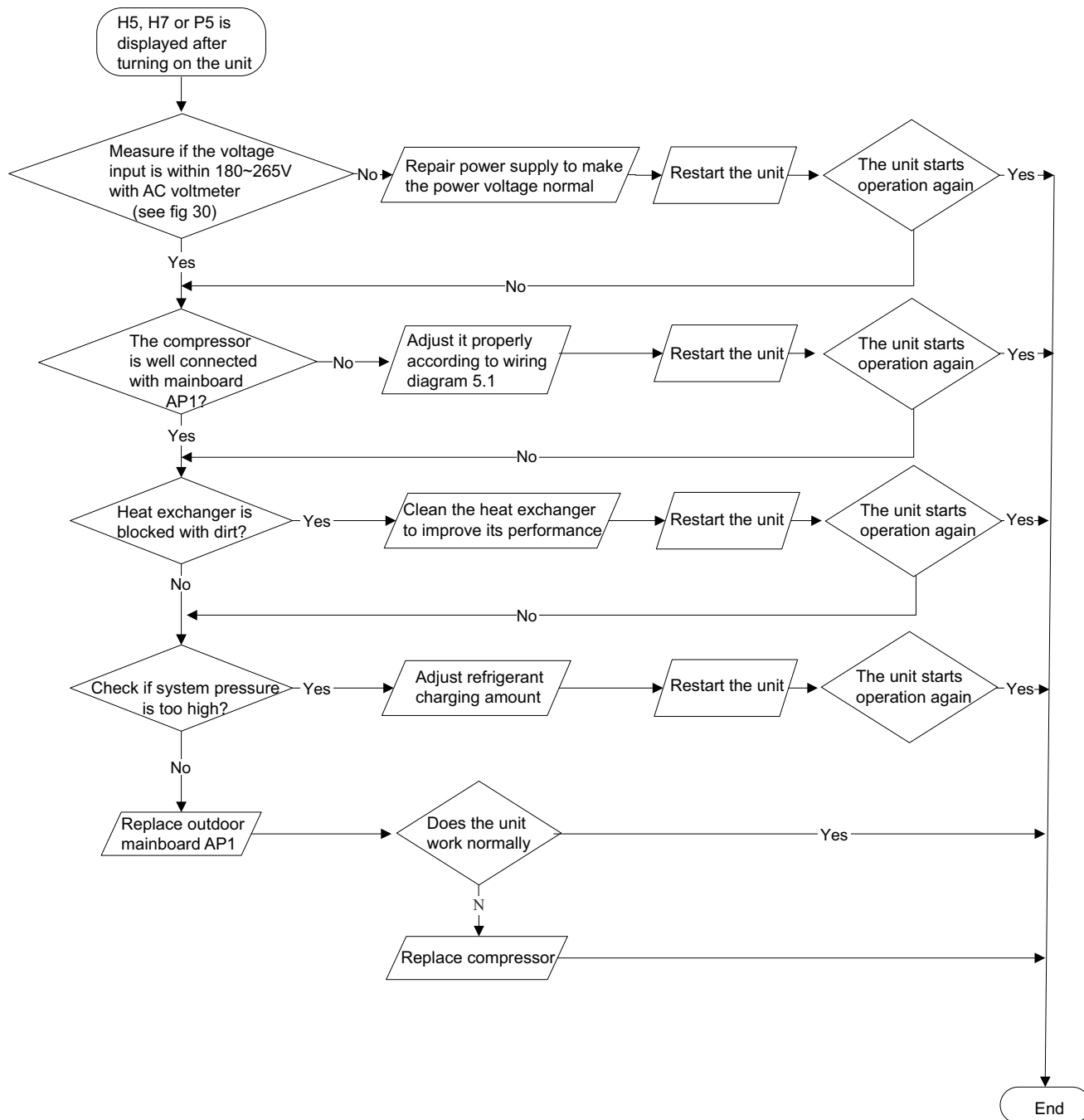

3. High temperature and overload protection (E8)(AP1 below means control board of outdoor unit)

Main detection points:

- If the outdoor ambient temperature is in normal range;
- If the indoor and outdoor fan are running normally;
- If the radiating environment of indoor and outdoor unit is good.

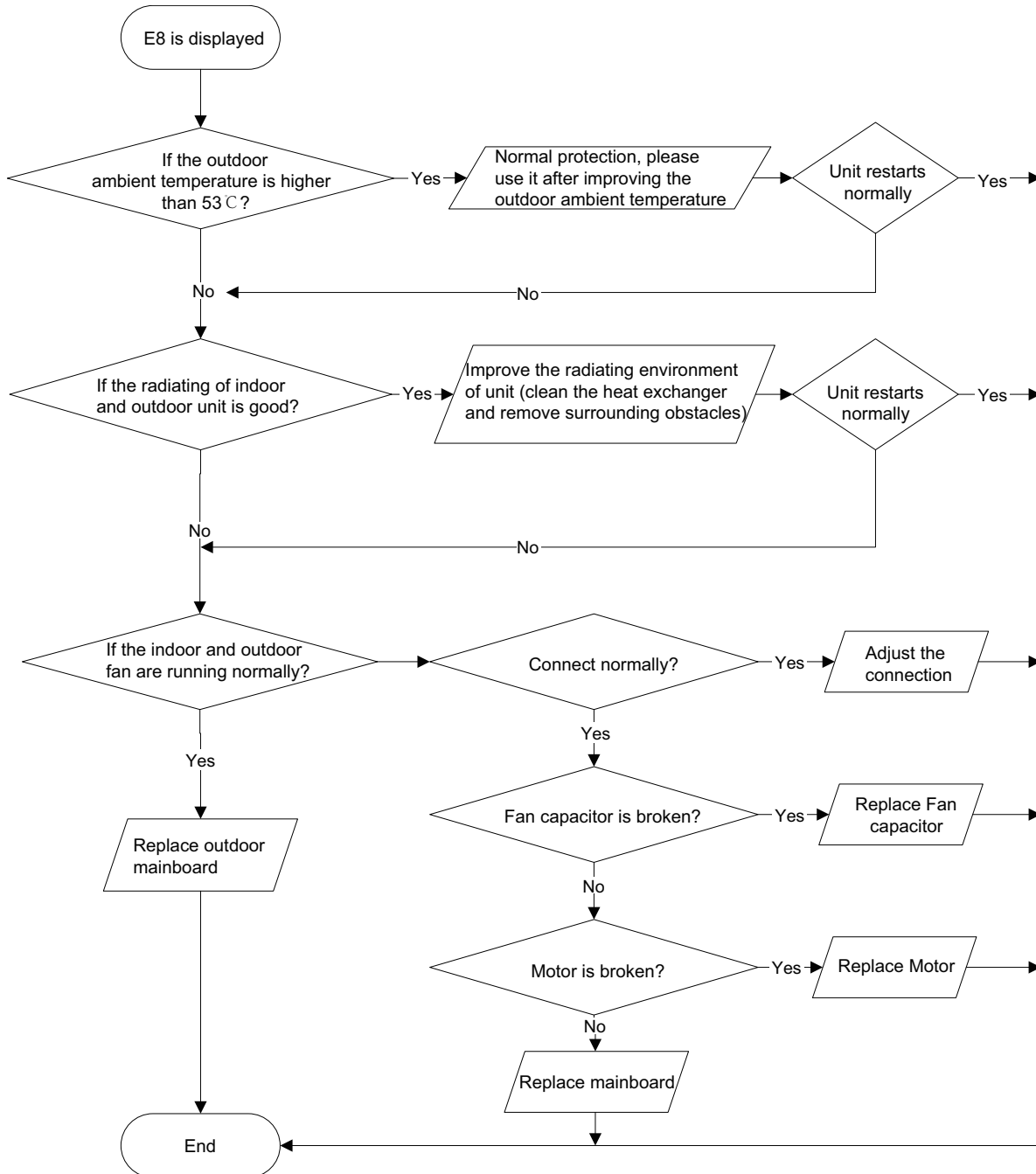

4. Start-up failure (LC) (AP1 below means control board of outdoor unit)

Main detection points:

- If the compressor wiring is correct?
- If the stop time of compressor is sufficient?
- If the compressor is damaged?
- If the refrigerant charging amount is too much?

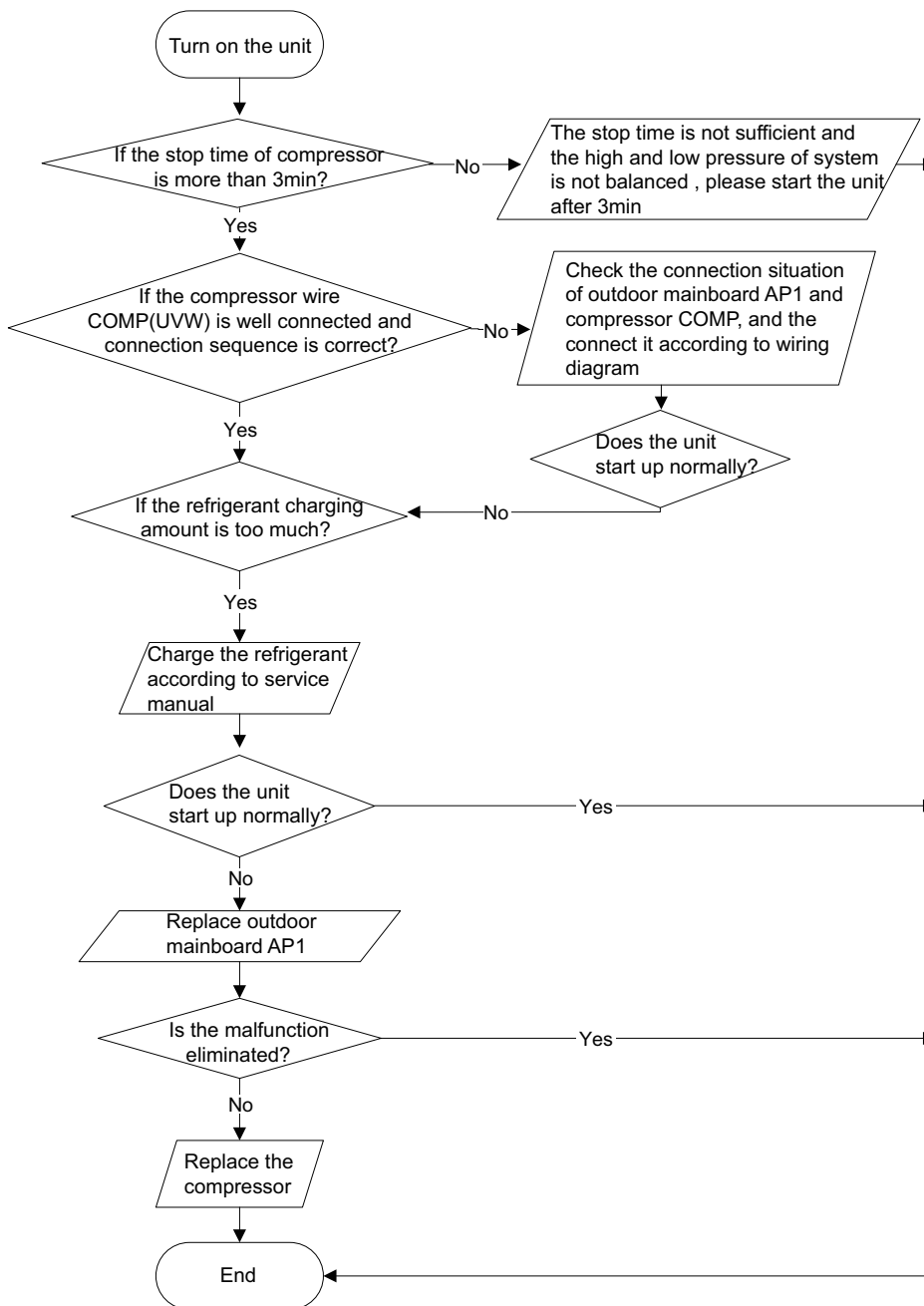

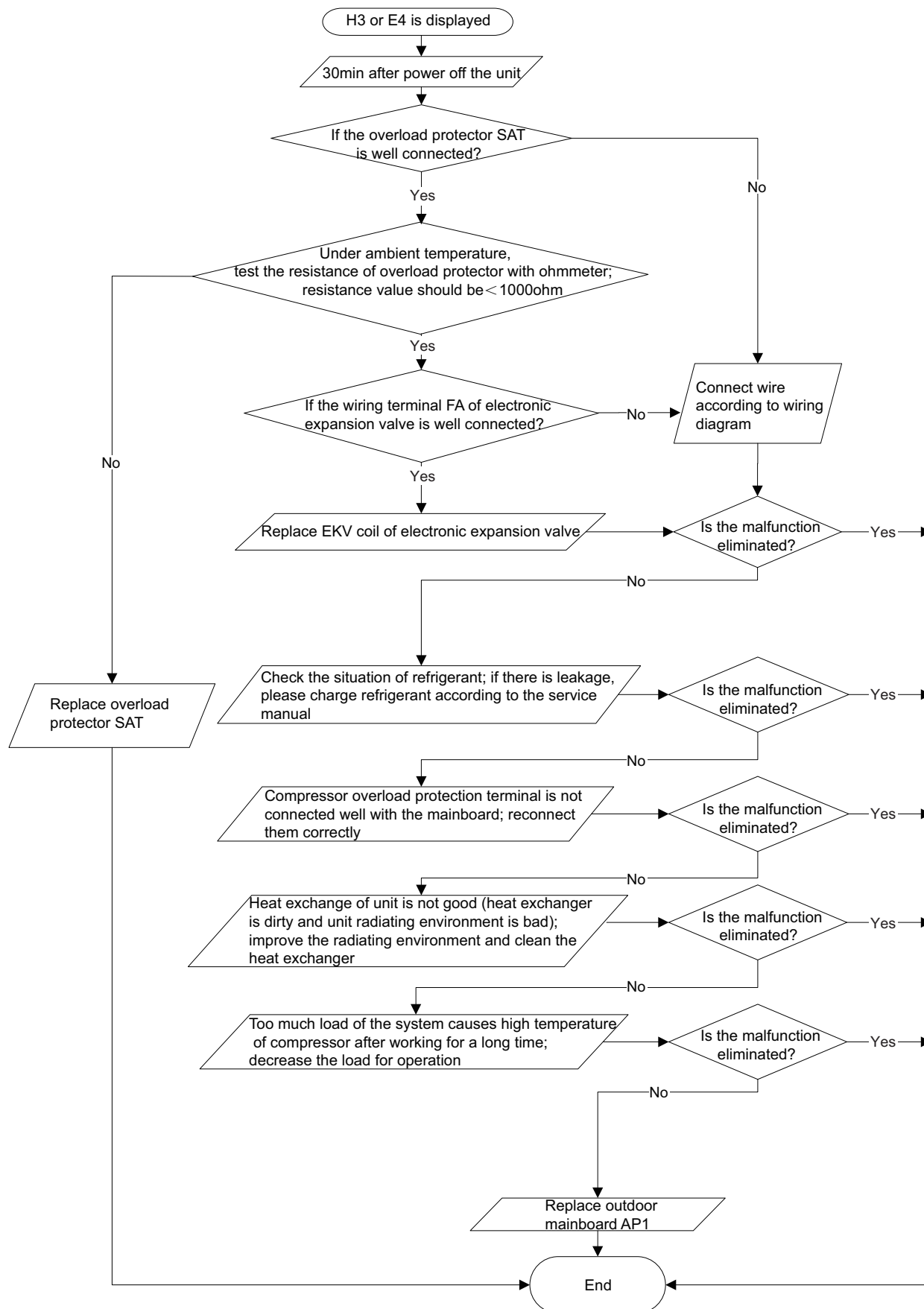

6. PFC (correction for power factor) malfunction (outdoor unit malfunction)

Main detection points:

- Check if power plug is connected well with the socket
- Check if the reactor of outdoor unit is damaged?

Malfunction diagnosis process:

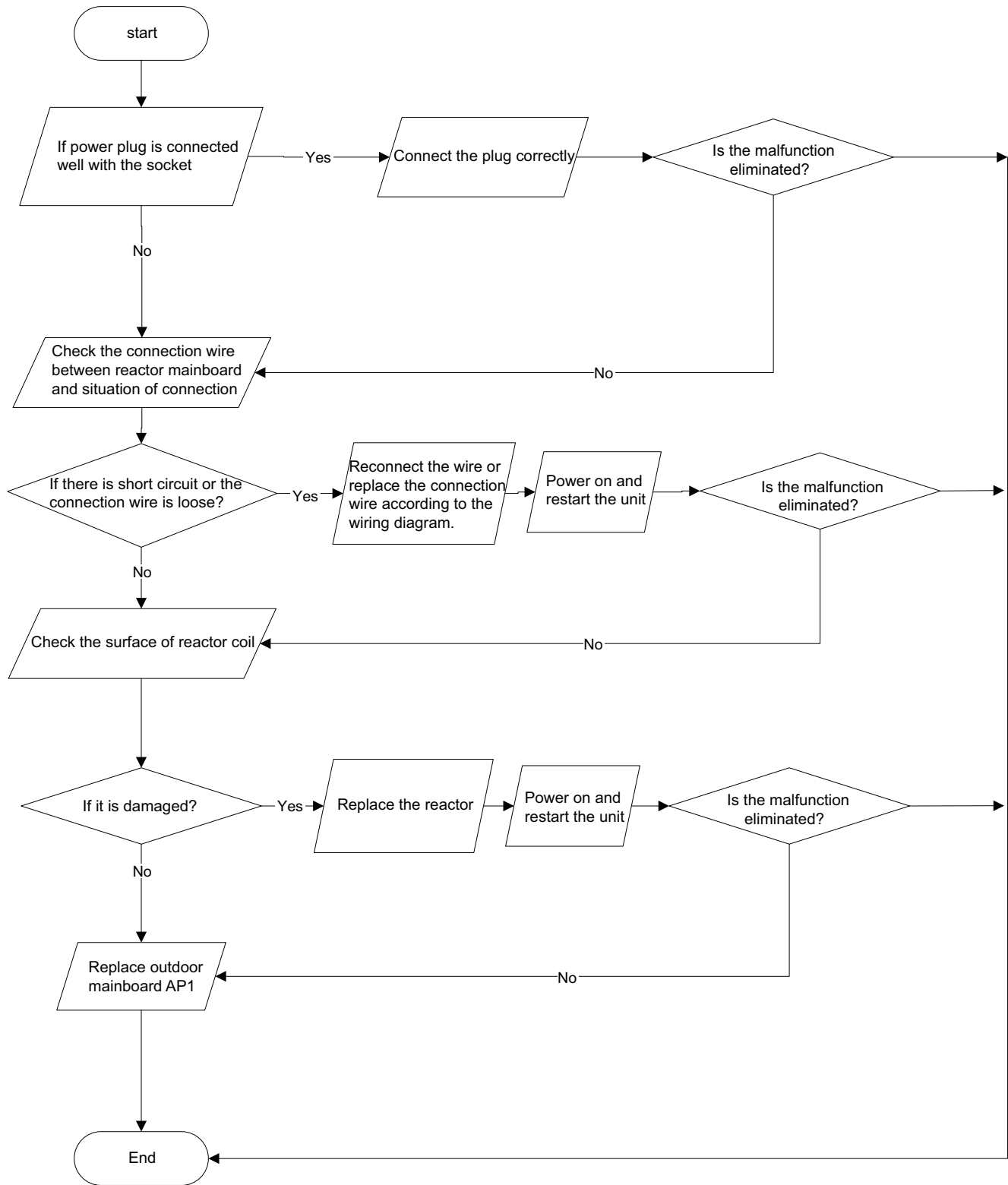

7. Communication malfunction (E6)

Main detection points:

- Check if the connection wire and the built-in wiring of indoor and outdoor unit are connected well and without damage;
- If the communication circuit of indoor mainboard is damaged? If the communication circuit of outdoor mainboard (AP1) is damaged?

Malfunction diagnosis process:

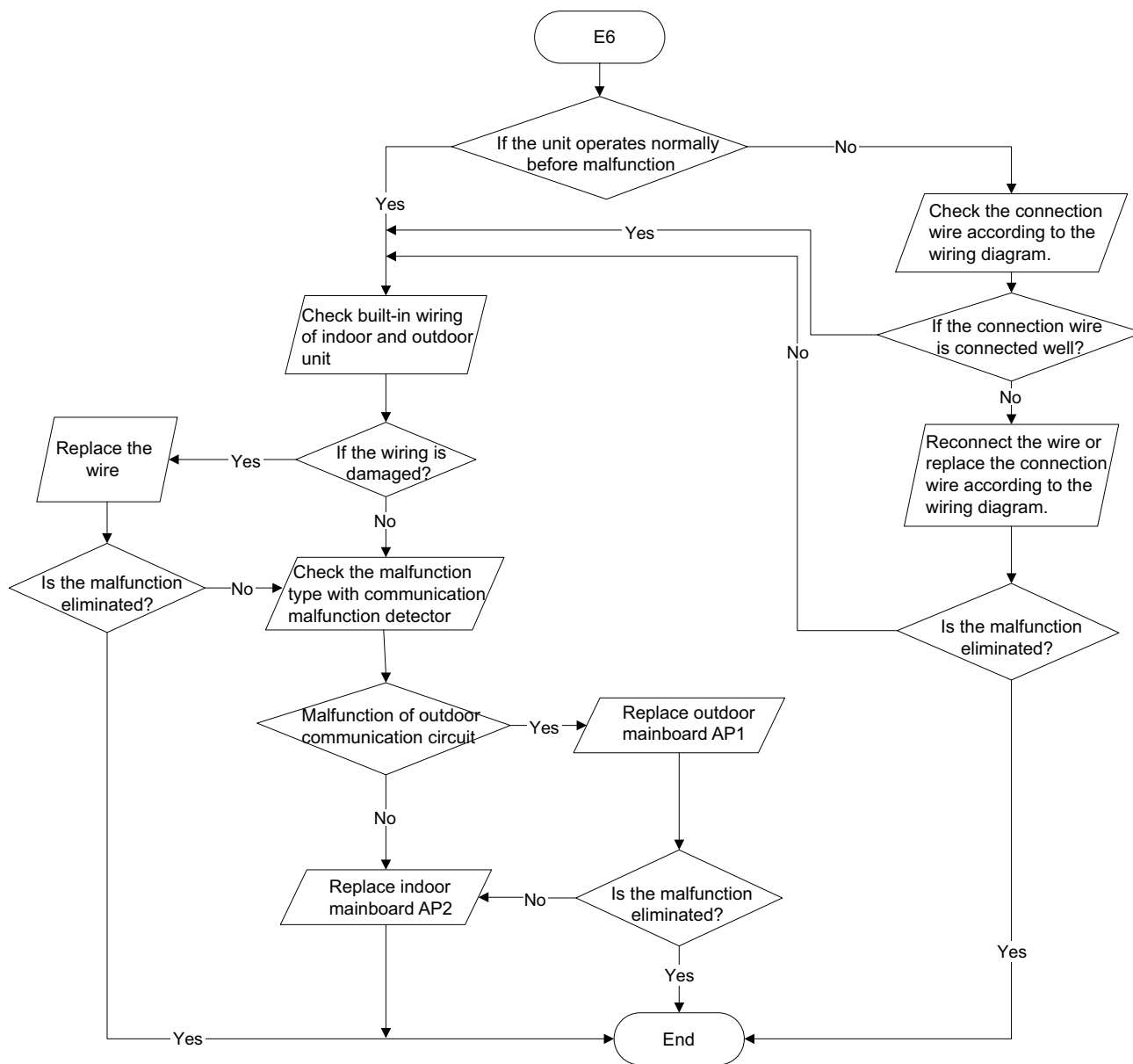

9.3 Troubleshooting for Normal Malfunction

1. Air Conditioner Can't be Started Up

Possible Causes	Discriminating Method (Air conditioner Status)	Troubleshooting
No power supply, or poor connection for power plug	After energization, operation indicator isn't bright and the buzzer can't give out sound	Confirm whether it's due to power failure. If yes, wait for power recovery. If not, check power supply circuit and make sure the power plug is connected well.
Wrong wire connection between indoor unit and outdoor unit, or poor connection for wiring terminals	Under normal power supply circumstances, operation indicator isn't bright after energization	Check the circuit according to circuit diagram and connect wires correctly. Make sure all wiring terminals are connected firmly
Electric leakage for air conditioner	After energization, room circuit breaker trips off at once	Make sure the air conditioner is grounded reliably Make sure wires of air conditioner is connected correctly Check the wiring inside air conditioner. Check whether the insulation layer of power cord is damaged; if yes, place the power cord.
Model selection for air switch is improper	After energization, air switch trips off	Select proper air switch
Malfunction of remote controller	After energization, operation indicator is bright, while no display on remote controller or buttons have no action.	Replace batteries for remote controller Repair or replace remote controller

2. Poor Cooling (Heating) for Air Conditioner

Possible Causes	Discriminating Method (Air conditioner Status)	Troubleshooting
Set temperature is improper	Observe the set temperature on remote controller	Adjust the set temperature
Rotation speed of the IDU fan motor is set too low	Small wind blow	Set the fan speed at high or medium
Filter of indoor unit is blocked	Check the filter to see it's blocked	Clean the filter
Installation position for indoor unit and outdoor unit is improper	Check whether the installation position is proper according to installation requirement for air conditioner	Adjust the installation position, and install the rainproof and sunproof for outdoor unit
Refrigerant is leaking	Discharged air temperature during cooling is higher than normal discharged wind temperature; Discharged air temperature during heating is lower than normal discharged wind temperature; Unit's pressure is much lower than regulated range	Find out the leakage causes and deal with it. Add refrigerant.
Malfunction of 4-way valve	Blow cold wind during heating	Replace the 4-way valve
Malfunction of capillary	Discharged air temperature during cooling is higher than normal discharged wind temperature; Discharged air temperature during heating is lower than normal discharged wind temperature; Unit's pressure is much lower than regulated range. If refrigerant isn't leaking, part of capillary is blocked	Replace the capillary
Flow volume of valve is insufficient	The pressure of valves is much lower than that stated in the specification	Open the valve completely
Malfunction of horizontal louver	Horizontal louver can't swing	Refer to point 3 of maintenance method for details
Malfunction of the IDU fan motor	The IDU fan motor can't operate	Refer to troubleshooting for H6 for maintenance method in details
Malfunction of the ODU fan motor	The ODU fan motor can't operate	Refer to point 4 of maintenance method for details
Malfunction of compressor	Compressor can't operate	Refer to point 5 of maintenance method for details

3. Horizontal Louver Can't Swing

Possible Causes	Discriminating Method (Air conditioner Status)	Troubleshooting
Wrong wire connection, or poor connection	Check the wiring status according to circuit diagram	Connect wires according to wiring diagram to make sure all wiring terminals are connected firmly
Stepping motor is damaged	Stepping motor can't operate	Repair or replace stepping motor
Main board is damaged	Others are all normal, while horizontal louver can't operate	Replace the main board with the same model

4. ODU Fan Motor Can't Operate

Possible causes	Discriminating method (air conditioner status)	Troubleshooting
Wrong wire connection, or poor connection	Check the wiring status according to circuit diagram	Connect wires according to wiring diagram to make sure all wiring terminals are connected firmly
Capacity of the ODU fan motor is damaged	Measure the capacity of fan capacitor with an universal meter and find that the capacity is out of the deviation range indicated on the nameplate of fan capacitor.	Replace the capacity of fan
Power voltage is a little low or high	Use universal meter to measure the power supply voltage. The voltage is a little high or low	Suggest to equip with voltage regulator
Motor of outdoor unit is damaged	When unit is on, cooling/heating performance is bad and ODU compressor generates a lot of noise and heat.	Change compressor oil and refrigerant. If no better, replace the compressor with a new one

5. Compressor Can't Operate

Possible causes	Discriminating method (air conditioner status)	Troubleshooting
Wrong wire connection, or poor connection	Check the wiring status according to circuit diagram	Connect wires according to wiring diagram to make sure all wiring terminals are connected firmly
Capacity of compressor is damaged	Measure the capacity of fan capacitor with an universal meter and find that the capacity is out of the deviation range indicated on the nameplate of fan capacitor.	Replace the compressor capacitor
Power voltage is a little low or high	Use universal meter to measure the power supply voltage. The voltage is a little high or low	Suggest to equip with voltage regulator
Coil of compressor is burnt out	Use universal meter to measure the resistance between compressor terminals and it's 0	Repair or replace compressor
Cylinder of compressor is blocked	Compressor can't operate	Repair or replace compressor

6. Air Conditioner is Leaking

Possible causes	Discriminating method (air conditioner status)	Troubleshooting
Drain pipe is blocked	Water leaking from indoor unit	Eliminate the foreign objects inside the drain pipe
Drain pipe is broken	Water leaking from drain pipe	Replace drain pipe
Wrapping is not tight	Water leaking from the pipe connection place of indoor unit	Wrap it again and bundle it tightly

7. Abnormal Sound and Vibration

Possible causes	Discriminating method (air conditioner status)	Troubleshooting
When turn on or turn off the unit, the panel and other parts will expand and there's abnormal sound	There's the sound of "PAPA"	Normal phenomenon. Abnormal sound will disappear after a few minutes.
When turn on or turn off the unit, there's abnormal sound due to flow of refrigerant inside air conditioner	Water-running sound can be heard	Normal phenomenon. Abnormal sound will disappear after a few minutes.
Foreign objects inside the indoor unit or there're parts touching together inside the indoor unit	There's abnormal sound fro indoor unit	Remove foreign objects. Adjust all parts' position of indoor unit, tighten screws and stick damping plaster between connected parts
Foreign objects inside the outdoor unit or there're parts touching together inside the outdoor unit	There's abnormal sound fro outdoor unit	Remove foreign objects. Adjust all parts' position of outdoor unit, tighten screws and stick damping plaster between connected parts
Short circuit inside the magnetic coil	During heating, the way valve has abnormal electromagnetic sound	Replace magnetic coil
Abnormal shake of compressor	Outdoor unit gives out abnormal sound	Adjust the support foot mat of compressor, tighten the bolts
Abnormal sound inside the compressor	Abnormal sound inside the compressor	If add too much refrigerant during maintenance, please reduce refrigerant properly. Replace compressor for other circumstances.

10. Exploded View and Parts List

10.1 Indoor Unit

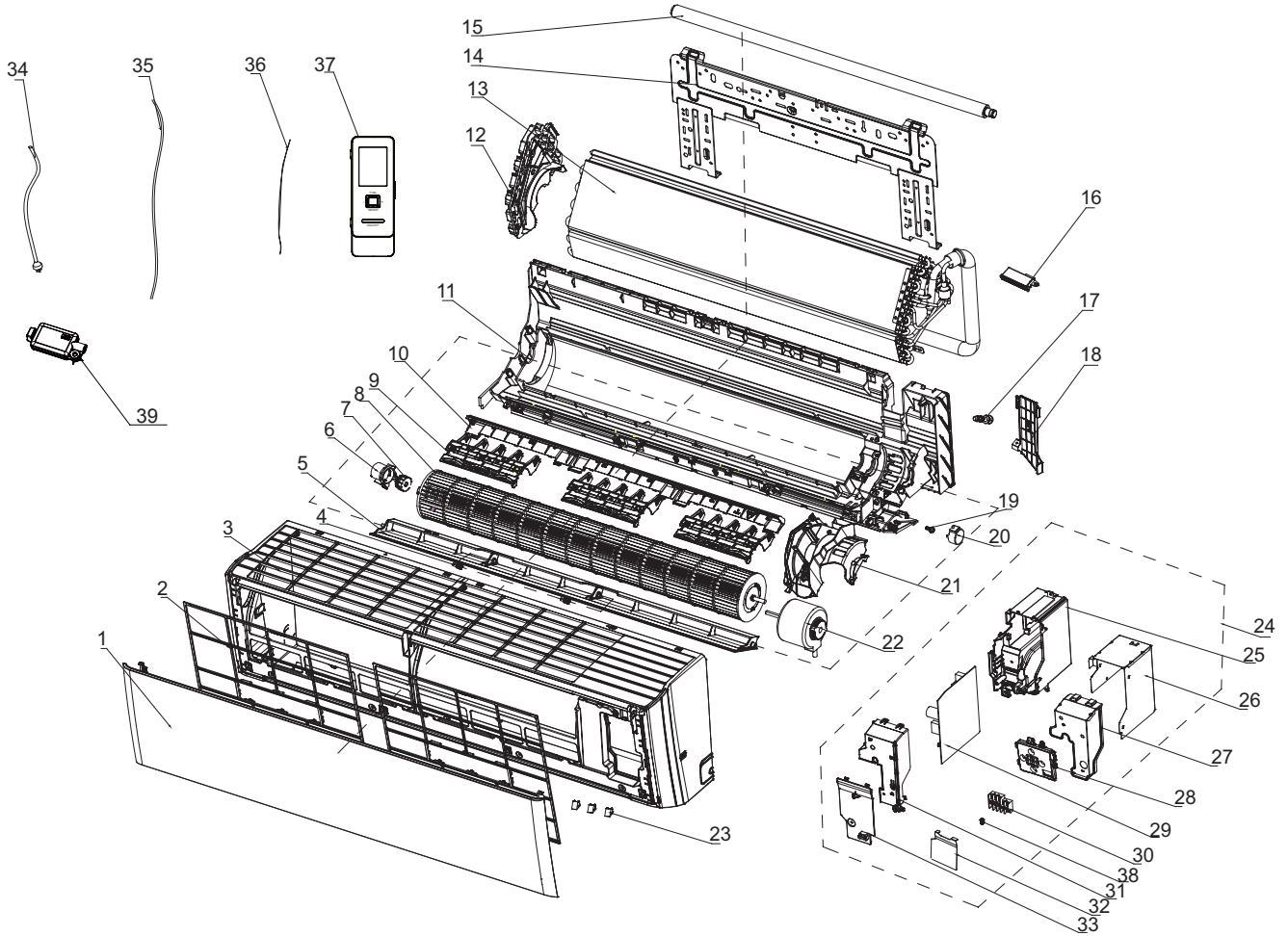

The component picture is only for reference; please refer to the actual product.

No.	Description	Part Code		Qty
		GWH09QD-D3DND6A/I	GWH12YD-D3DNA1A/I	
Product Code		CB437N01200	CB437N00900	
1	Front Panel(low display)	20000300057T	20000300057T	1
2	Filter Sub-Assy	11122089	11122089	2
3	Front Case Sub-Assy	00000200060	00000200060	1
4	Axile Bush	10542036	10542036	2
5	Guide Louver	10512501	10512501	1
6	Ring of Bearing	26152025	26152025	1
7	O-Gasket of Cross Fan Bearing	76512203	76512203	1
8	Cross Flow Fan	10352060	10352060	1
9	Air Louver(Manual)	10512736	10512736	3
10	Helicoid Tongue	26112512	26112512	1
11	Rear Case assy	00000100177	00000100177	1
12	Evaporator Support	24212177	24212177	1
13	Evaporator Assy	0100200001401	0100200001401	1
14	Wall Mounting Frame	01362026	01362026	1
15	Drainage Hose	05230014	05230014	1
16	Cold Plasma Generator	/	/	/
17	Rubber Plug (Water Tray)	76712012	76712012	1
18	Connecting pipe clamp	2611218801	2611218801	1
19	Crank	73012005	73012005	1
20	Stepping Motor	1521240212	1521240212	1
21	Motor Press Plate	26112511	26112511	1
22	Fan Motor	15012136	15012136	1
23	Screw Cover	2425201726	2425201726	3
24	Electric Box Assy	10000204907	10000204767	1
25	Electric Box	2011221102	2011221102	1
26	Lower Shield of Electric Box	01592139	01592139	1
27	Shield Cover of Electric Box	01592176	01592176	1
28	Display Board	30565260	30565260	1
29	Main Board	300002000093	300002000093	1
30	Terminal Board	42011233	42011233	1
31	Electric Box Cover	2011220901	2011220901	1
32	Electric Box Cover2	2011221001	2011221001	1
33	Shield Cover of Electric Box Cover 2	01202000099	01202000099	1
34	Connecting Cable	400205382	400205382	0
35	Connecting Cable	/	/	/
36	Temperature Sensor	3900031302	3900031302	1
37	Remote Controller	30510138	30510138	1
38	Jumper	4202021911	4202021912	1
39	Detecting Plate	30070077	30070077	1

Above data is subject to change without notice.

10.2 Outdoor Unit

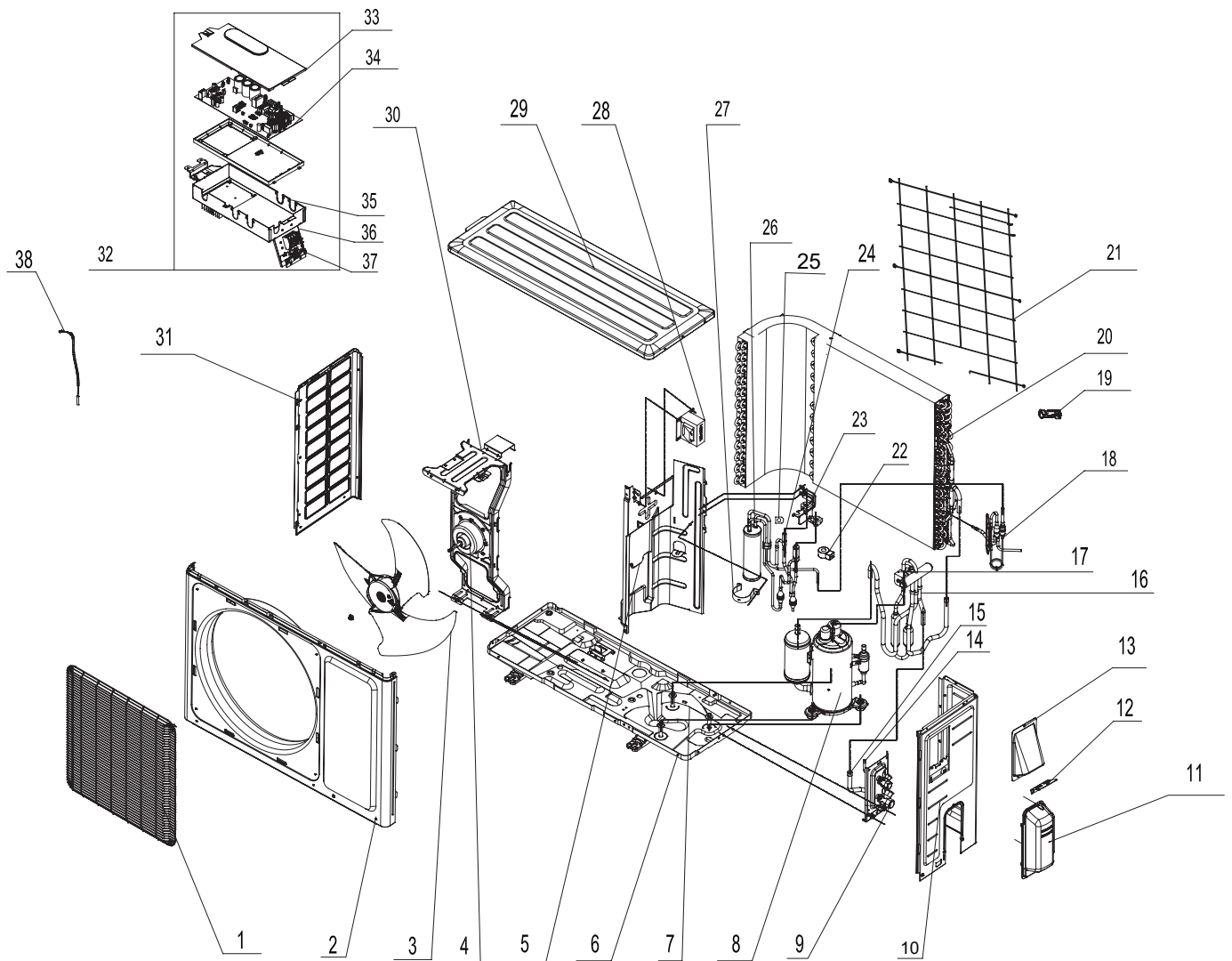

The component picture is only for reference; please refer to the actual product.

No.	Description	Part Code		Qty
		GWH09YD-D3DNA1A/O	GWH12YD-D3DNA1A/O	
	Product Code	CB437W01200	CB437W00900	
1	Front Grill	01473065	01473065	1
2	Cabinet	0143303402P	0143303402P	1
3	Axial Flow Fan	10333022	10333022	1
4	Fan Motor	1501308511	1501308511	1
5	Clapboard	01233510	01233510	1
6	Chassis Sub-assy	0280311901P	0280311901P	1
7	Electrical Heater (Chassis)	76510004	76510004	1
8	Compressor and Fittings	00103977	00103977	1
9	Valve Support Sub-Assy	01703242P	01713115P	1
10	Right Side Plate	0130510002P	0130510002P	1
11	Valve Cover	22243005	22243005	1
12	Cable Cross Plate 1	02123013P	02123013P	1
13	Cable Cross Plate 2	02123014P	02123014P	1
14	Cut off Valve Sub-Assy	0713376301	0713376301	1
15	Cut off Valve 1/2	07100006	0710307901	1
16	4-Way Valve Assy	03073358	03073360	1
17	Magnet Coil	4300008301	4300008301	1
18	Capillary Sub-assy	03000600300	03000600305	1
19	Wiring Clamp	26115004	26115004	1
20	Condenser Assy	01100200314	01100200318	1
21	Rear Grill	0147306001	0147306001	1
22	Electric Expand Valve Fitting	4300876704	4300876704	1
23	Stationary Barrier	01703179	01703179	1
24	Electronic Expansion Valve	07133909	07133909	1
25	Flash Vaporizer Sub-assy	07223057	03007000001	1
26	Magnet Coil	4300008301	4300040047	1
27	Tube Clip	02143030	02143030	1
28	Reactor	43130185	43130185	1
29	Coping	01253034P	01253034P	1
30	Motor Support Sub-Assy	01703180	01703180	1
31	Left Side Plate	01303169P	01303169P	1
32	Electric Box Assy	10000100921	10000100908	1
33	Electric Box Cover Sub-Assy	0260309601	0260309601	1
34	Main Board	300027000087	300027000057	1
35	Electric Box 1	20113005	20113005	1
36	Terminal Board	42010313	42010313	1
37	Wire Clamp	71010003	71010003	2
38	Temperature Sensor	39000079	3900007901	1

Above data is subject to change without notice.

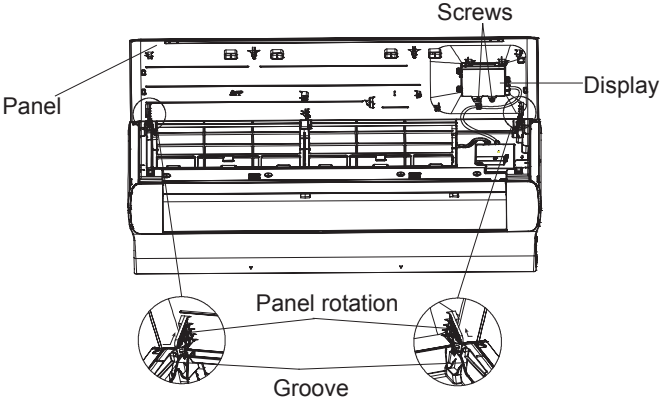
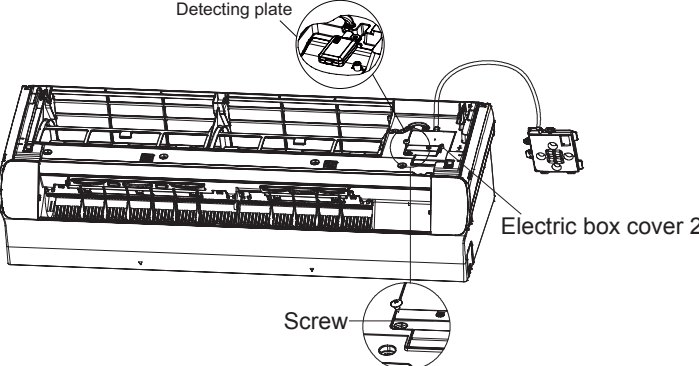
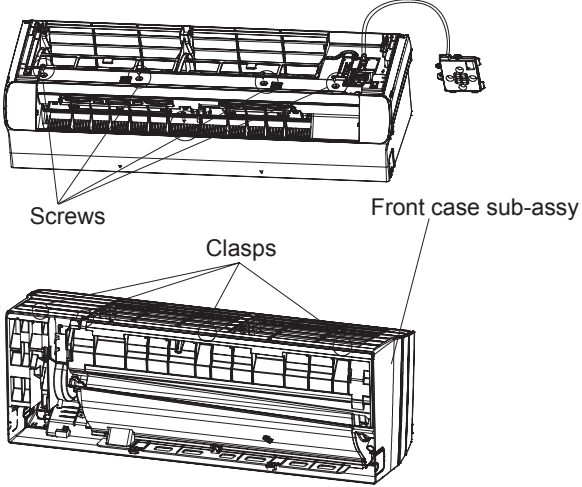
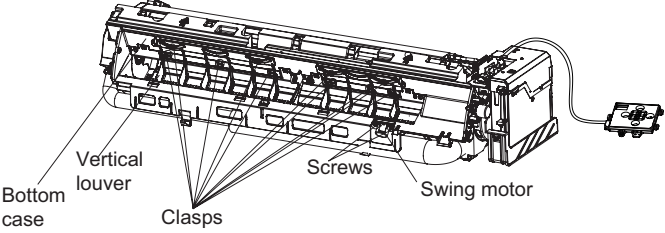
Step	Procedure	Diagram
<p>3.Remove display and panel</p> <p>a. Screws that are locking the display board. Separate the display board from the front panel.</p> <p>b. Open the front panel; separate the panel rotation shaft from the groove fixing the front panel and then removes the front panel.</p>		
<p>4.Remove detecting plate and electric box cover2</p>	<p>Remove the screws fixing detecting plate and remove detecting plate.</p> <p>Remove the screws fixing electric box cover2 and remove electric box2.</p>	
<p>5.Remove front case sub-assy</p>	<p>Remove the screws fixing front case. Loosen the clasps of front case Life the front case sub-assy upwards to remove it.</p>	
<p>6. Remove vertical louver</p>	<p>Loosen the connection clasps between vertical louver and bottom case to remove vertical louver.</p> <p>Remove the swing motor by screwing off the connecting screws.</p>	

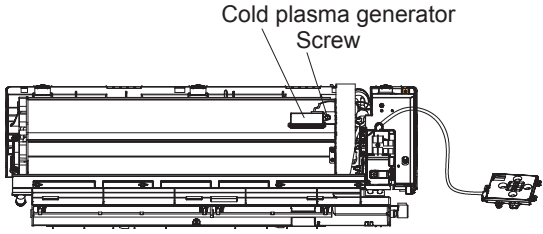
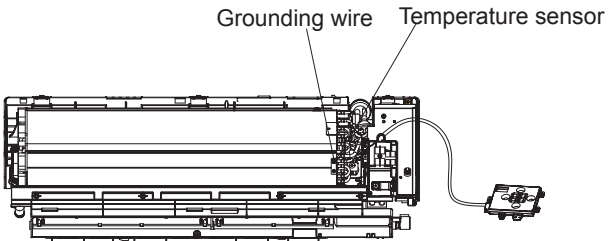
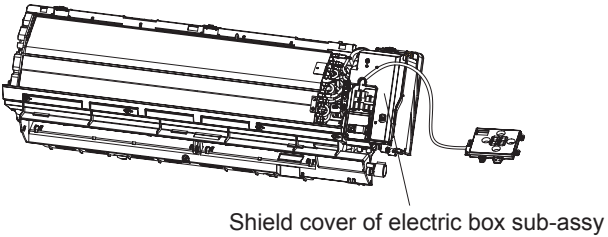
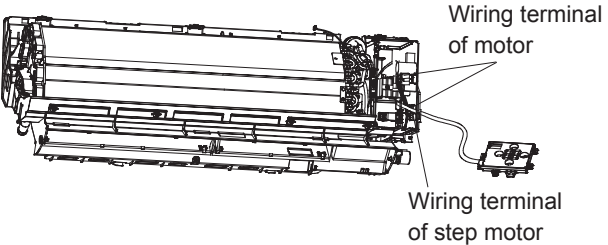
Step	Procedure	
7.Remove cold plasma generator	<p data-bbox="269 302 678 390">Screws that are locking the cold plasma generator. Separate the display board from the evaporator assy.</p> <div data-bbox="899 289 1438 520">  <p data-bbox="1117 289 1354 340">Cold plasma generator Screw</p> </div>	
8.Remove temperature sensor and grounding wire	<p data-bbox="269 699 683 940">Cut off the tieline which binding the temperature sensor and grounding wire on the evaporator, and then pull out the indoor tube temperature sensor from the evaporator. Remove the screws at the connection place between grounding wire and evaporator.</p> <div data-bbox="899 646 1503 884">  <p data-bbox="1110 646 1503 676">Grounding wire Temperature sensor</p> </div>	
9.Remove shield cover of electric box sub-assy	<p data-bbox="269 1113 686 1230">Loosen the connection clasps between shield cover of electric box sub-assy and electric box, and then remove the shield cover of electric box sub-assy.</p> <div data-bbox="899 1115 1503 1350">  <p data-bbox="1122 1323 1503 1350">Shield cover of electric box sub-assy</p> </div>	
10.Remove wiring terminal	<p data-bbox="269 1560 691 1770">Pull out the wiring terminal of motor and wiring terminal of step motor from the mainboard. Note: When pulling out the wiring terminal, pay attention to loose the clasp and don't pull it so hard.</p> <div data-bbox="899 1549 1503 1791">  <p data-bbox="1341 1549 1503 1604">Wiring terminal of motor</p> <p data-bbox="1300 1734 1463 1791">Wiring terminal of step motor</p> </div>	

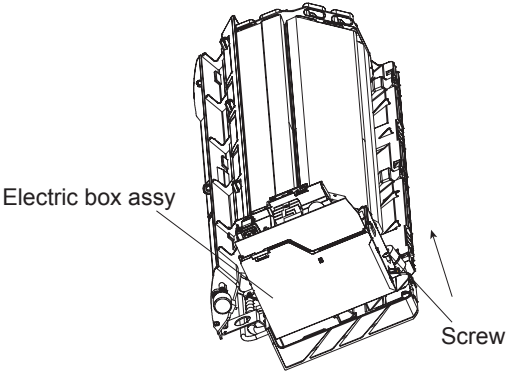
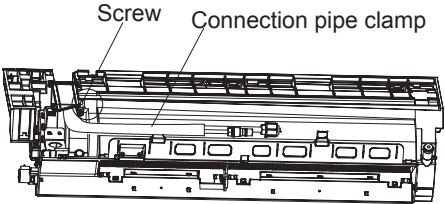
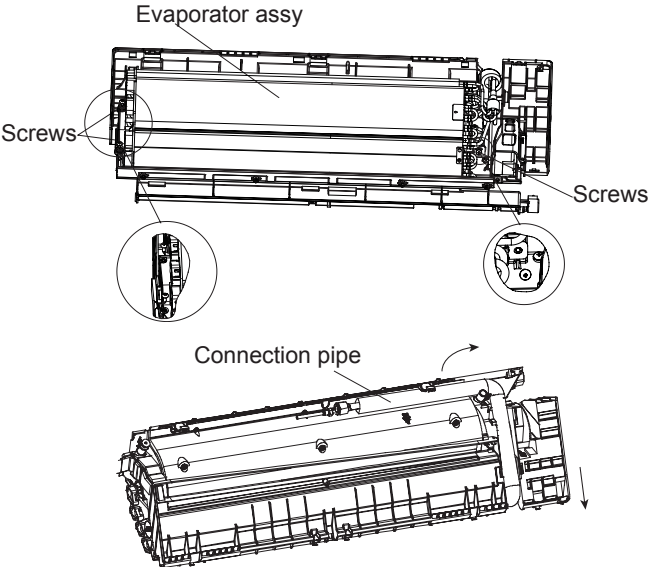
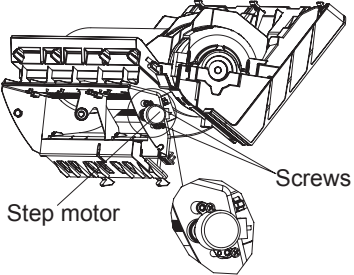
Step	Procedure
11. Electric box assy	<p>Remove the screw fixing electric box assy and then remove the electric box assy.</p> 
12. Remove connection pipe clamp	<p>At the back of the unit, remove the screw fixing connection pipe clamp and then remove the connection pipe clamp.</p> 
13. Remove evaporator assy	<p>Remove 3 screws fixing evaporator assy. Adjust the position of connection pipe on evaporator slightly and then lift the evaporator upwards to remove it.</p> 
14. Remove stepping motor	<p>Remove the screw fixing step motor and then remove the step motor.</p> 

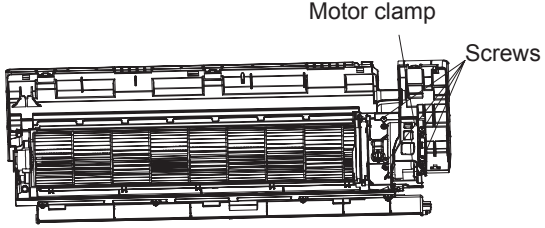
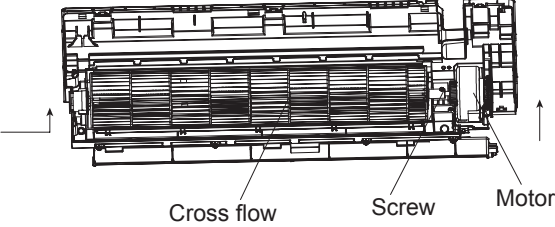
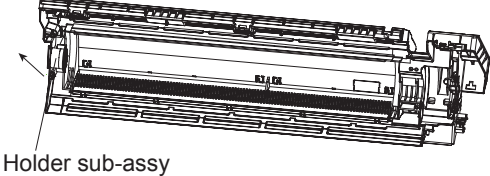
Step	Procedure
15.Remove motor and cross flow blade	
a.	<p>Remove the screws fixing motor clamp and then remove the motor clamp.</p> 
b.	<p>Remove the screws at the connection place of cross flow blade and motor; lift the motor and cross flow blade upwards to remove them.</p> 
c.	<p>Remove the bearing holder sub-assy.</p> 

11.2 Removal Procedure of Outdoor Unit

⚠ Warning: Be sure to wait for a minimum of 20 minutes after turning off all power supplies and discharge the refrigerant completely before removal.

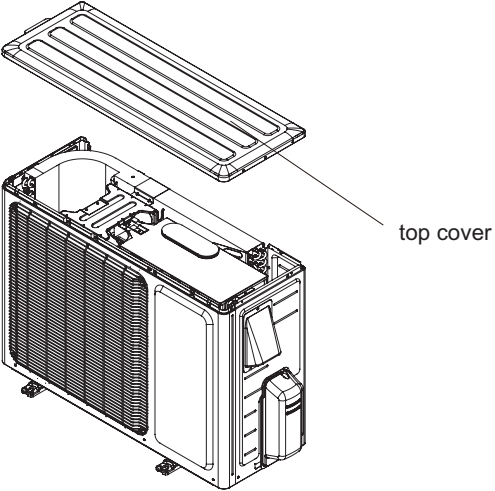
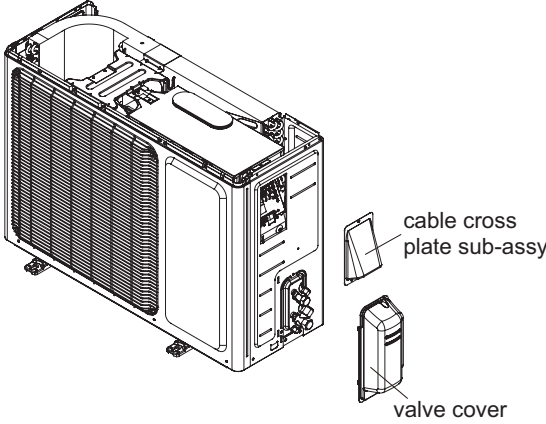
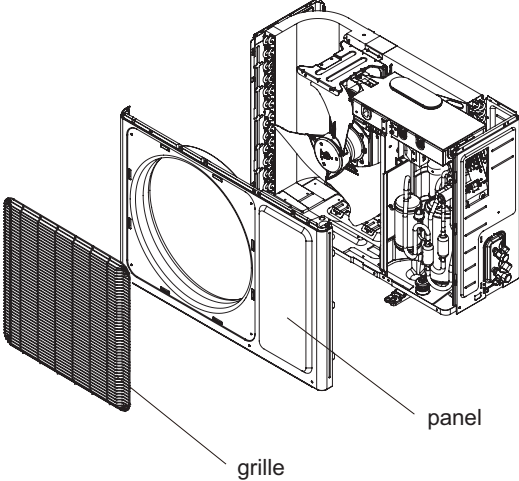
Steps	Procedure
<p>1. Remove top cover</p>	<p>Remove the screws connecting top cover, left and right side plate, as well as panel, to remove the top cover.</p> 
<p>2. Remove cable cross plate sub-assy and valve cover</p>	<p>Remove the screws connecting cable cross plate sub-assy and right side plate, to remove the cable cross plate sub-assy. Remove the screw fixing valve cover, to remove the cover.</p> 
<p>3. Remove panel and grille</p>	<p>Remove the screws fixing panel, to remove the panel. Remove the screws connecting panel grille and panel, loosen the clamp, to remove the panel grille.</p> 

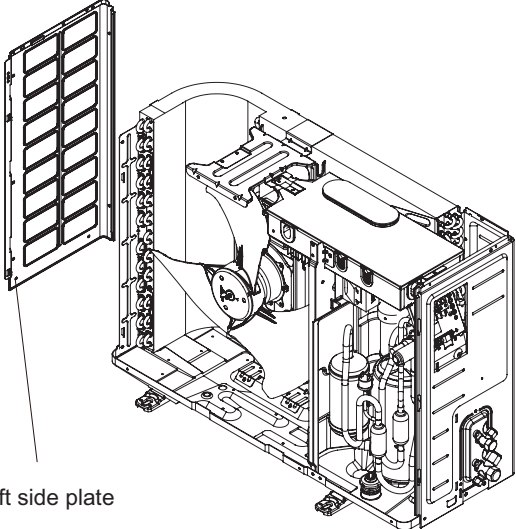
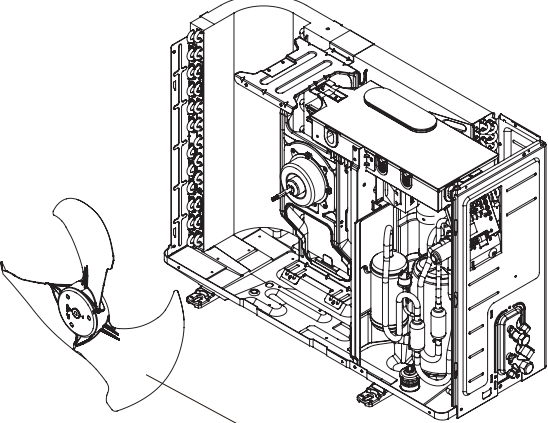
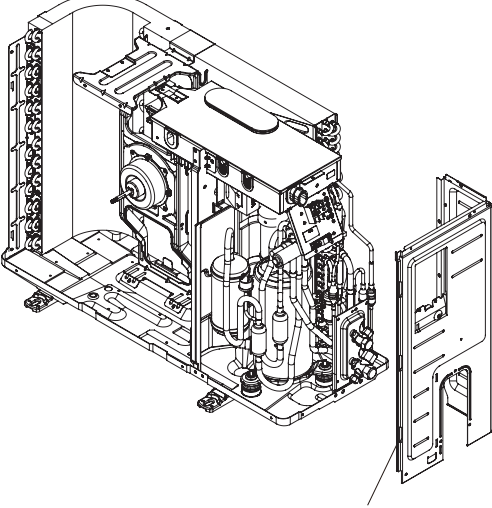
Steps	Procedure
<p>4. Remove left side plate</p>	<p>Remove the screws fixing left side plate and condenser support board, to remove the left side plate.</p>  <p>left side plate</p>
<p>5. Remove cross fan blade</p>	<p>Remove the screw nut fixing cross fan blade, remove the gasket and spring cushion, to remove the cross fan blade.</p>  <p>cross fan blade</p>
<p>6. Remove right side plate</p>	<p>Remove the screws fixing right side plate and valve support, to remove the right side plate.</p>  <p>right side plate</p>

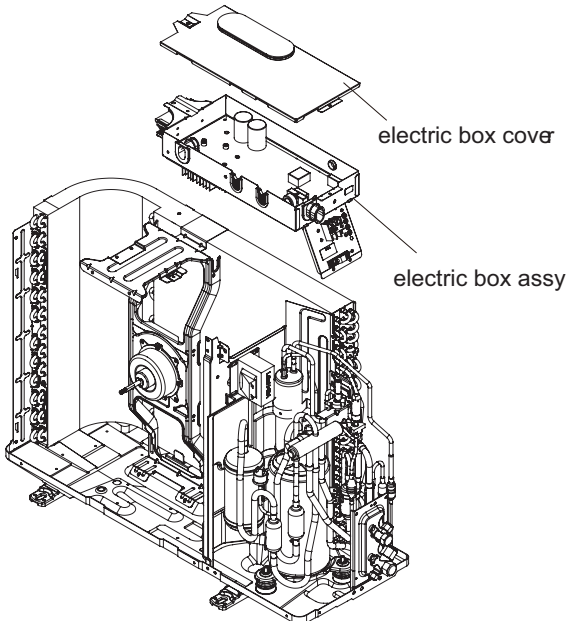
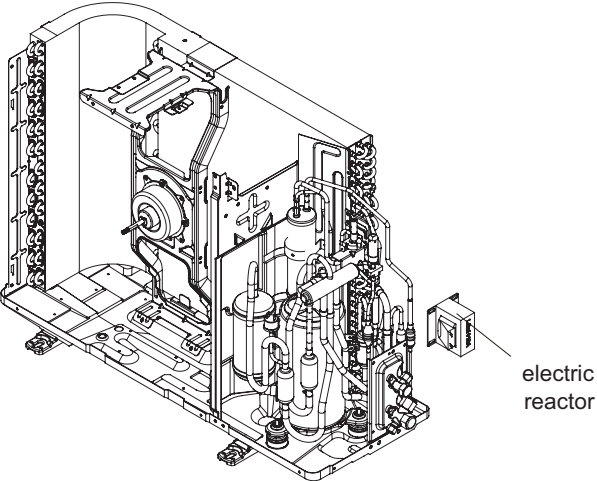
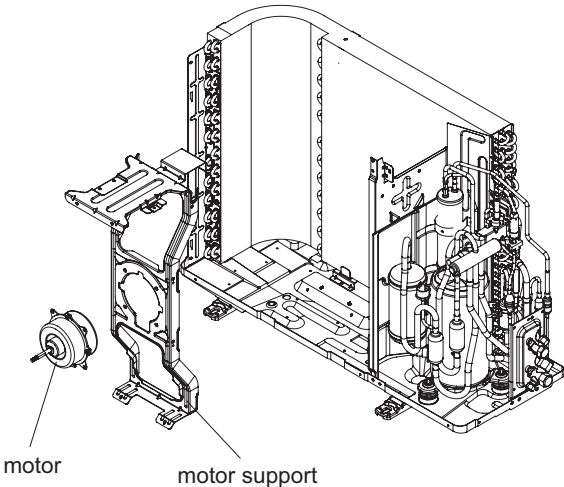
Steps	Procedure
<p>7. Remove electric box assy</p>	<p>Remove screws fixing electric box assy and mid-isolation board, loosen the bonding tie, pull off the wiring terminal, lift to remove the electric box assy.</p> 
<p>8. Remove electric reactor</p>	<p>Remove the screws fixing electric reactor, to remove the electric reactor.</p> 
<p>9. Remove motor and motor support</p>	<p>Remove the four tapping screws fixing motor, pull out the contact tag of motor wiring, to remove the motor. Remove the two tapping screws fixing motor support and chassis, lift to remove the motor support.</p> 

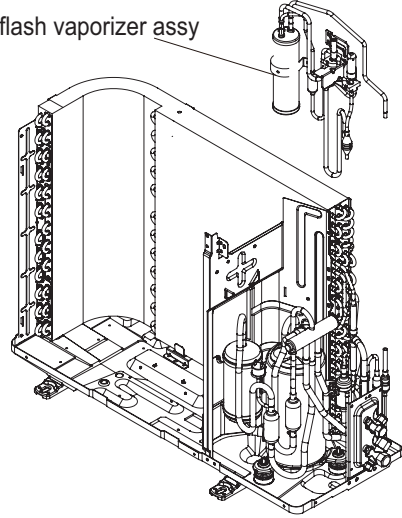
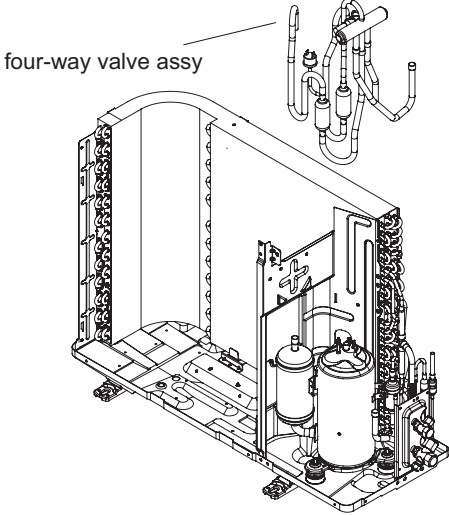
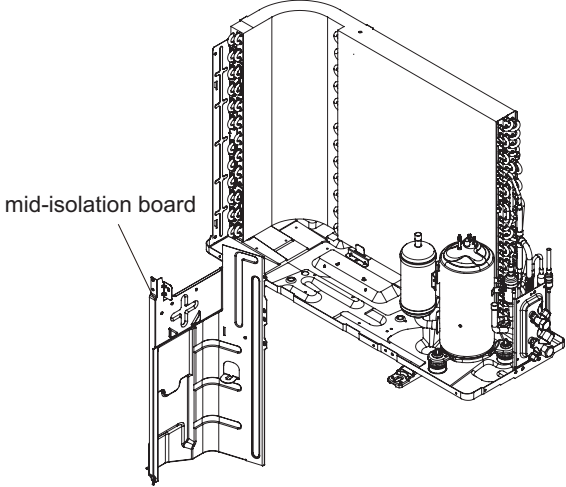
Steps	Procedure
<p>10. Remove flash vaporizer assy</p>	<p>Remove the screws connecting mid-isolation board, lift to remove the flash vaporizer assy.</p> 
<p>11. Remove four-way valve assy</p>	<p>Welding cut the spot weld of four-way valve assy, compressor air suction/discharging valve and condenser pipe outlet, lift to remove the four-way valve assy. (Note: release the refrigerant before welding cutting.)</p> 
<p>12. Remove mid-isolation board</p>	<p>Remove the screws connecting mid-isolation board, chassis and condenser assy, to remove the mid-isolation.</p> 

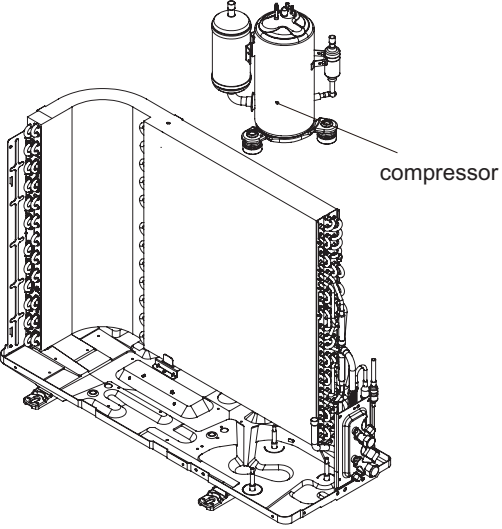
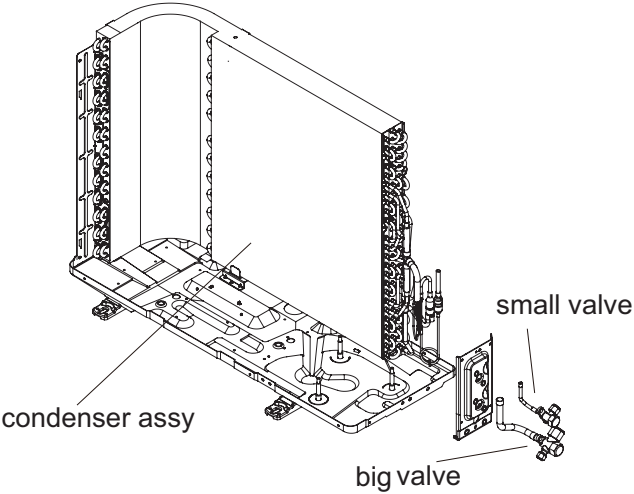
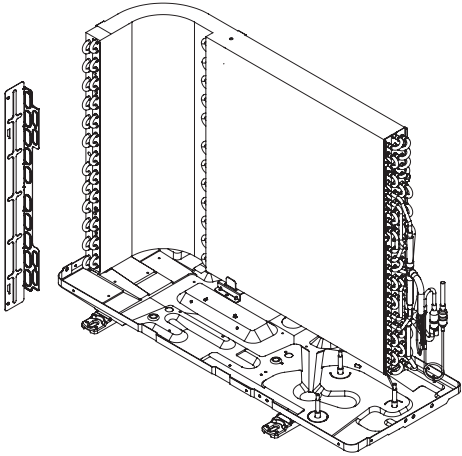
Steps	Procedure
13. Remove compressor	<p>Remove the three feet screwnuts fixing compressor, to remove the compressor.</p> 
14. Remove big and small valve assy	<p>Remove screws connecting condenser assy and chassis, to remove the condenser assy. Remove the screws fixing big and small valve, to remove the valves.</p> 
15. Remove chassis sub-assy	<p>Remove screws connecting condenser assy and chassis, to remove the chassis sub-assy.</p> 

Appendix:

Appendix 1: Reference Sheet of Celsius and Fahrenheit

Conversion formula for Fahrenheit degree and Celsius degree: $T_f = T_c \times 1.8 + 32$

Set temperature

Fahrenheit display temperature (°F)	Fahrenheit (°F)	Celsius (°C)	Fahrenheit display temperature (°F)	Fahrenheit (°F)	Celsius (°C)	Fahrenheit display temperature (°F)	Fahrenheit (°F)	Celsius (°C)
61	60.8	16	69/70	69.8	21	78/79	78.8	26
62/63	62.6	17	71/72	71.6	22	80/81	80.6	27
64/65	64.4	18	73/74	73.4	23	82/83	82.4	28
66/67	66.2	19	75/76	75.2	24	84/85	84.2	29
68	68	20	77	77	25	86	86	30

Ambient temperature

Fahrenheit display temperature (°F)	Fahrenheit (°F)	Celsius (°C)	Fahrenheit display temperature (°F)	Fahrenheit (°F)	Celsius (°C)	Fahrenheit display temperature (°F)	Fahrenheit (°F)	Celsius (°C)
32/33	32	0	55/56	55.4	13	79/80	78.8	26
34/35	33.8	1	57/58	57.2	14	81	80.6	27
36	35.6	2	59/60	59	15	82/83	82.4	28
37/38	37.4	3	61/62	60.8	16	84/85	84.2	29
39/40	39.2	4	63	62.6	17	86/87	86	30
41/42	41	5	64/65	64.4	18	88/89	87.8	31
43/44	42.8	6	66/67	66.2	19	90	89.6	32
45	44.6	7	68/69	68	20	91/92	91.4	33
46/47	46.4	8	70/71	69.8	21	93/94	93.2	34
48/49	48.2	9	72	71.6	22	95/96	95	35
50/51	50	10	73/74	73.4	23	97/98	96.8	36
52/53	51.8	11	75/76	75.2	24	99	98.6	37
54	53.6	12	77/78	77	25			

Appendix 2: Configuration of Connection Pipe

- Standard length of connection pipe
 - 5m, 7.5m, 8m.
- Min. length of connection pipe is 3m.
- Max. length of connection pipe and max. high difference.
- The additional refrigerant oil and refrigerant charging required after prolonging connection pipe
 - After the length of connection pipe is prolonged for 10m at the basis of standard length, you should add 5ml of refrigerant oil for each additional 5m of connection pipe.
 - The calculation method of additional refrigerant charging amount (on the basis of liquid pipe):

Cooling capacity	Max length of connection pipe	Max height difference
5000 Btu/h(1465 W)	15 m	5 m
7000 Btu/h(2051 W)	15 m	5 m
9000 Btu/h(2637 W)	15 m	10 m
12000 Btu/h(3516 W)	20 m	10 m
18000 Btu/h(5274 W)	25 m	10 m
24000 Btu/h(7032 W)	25 m	10 m
28000 Btu/h(8204 W)	30 m	10 m
36000 Btu/h(10548 W)	30 m	20 m
42000 Btu/h(12306 W)	30 m	20 m
48000 Btu/h(14064 W)	30 m	20 m

- When the length of connection pipe is above 5m, add refrigerant according to the prolonged length of liquid pipe. The additional refrigerant charging amount per meter is different according to the diameter of liquid pipe. See the following sheet.
- Additional refrigerant charging amount = prolonged length of liquid pipe X additional refrigerant charging amount per meter

Additional refrigerant charging amount for R22, R407C, R410A and R134a			
Diameter of connection pipe		Outdoor unit throttle	
Liquid pipe(mm)	Gas pipe(mm)	Cooling only(g/m)	Cooling and heating(g/m)
Φ6	Φ9.5 or Φ12	15	20
Φ6 or Φ9.5	Φ16 or Φ19	15	20
Φ12	Φ19 or Φ22.2	30	120
Φ16	Φ25.4 or Φ31.8	60	120
Φ19	/	250	250
Φ22.2	/	350	350

Appendix 3: Pipe Expanding Method

⚠ Note:

Improper pipe expanding is the main cause of refrigerant leakage. Please expand the pipe according to the following steps:

A: Cut the pip

- Confirm the pipe length according to the distance of indoor unit and outdoor unit.
- Cut the required pipe with pipe cutter.

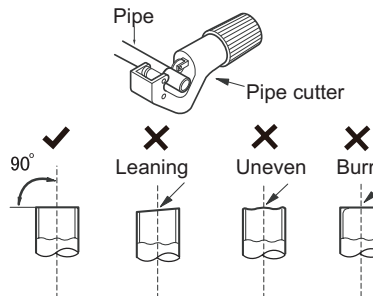

B: Remove the burrs

- Remove the burrs with shaper and prevent the burrs from getting into the pipe.

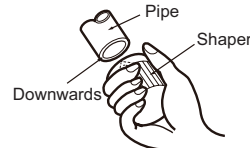

C: Put on suitable insulating pipe

D: Put on the union nut

- Remove the union nut on the indoor connection pipe and outdoor valve; install the union nut on the pipe.

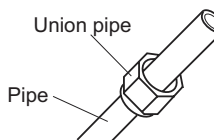

E: Expand the port

- Expand the port with expander.

⚠ Note:

- "A" is different according to the diameter, please refer to the sheet below:

Outer diameter(mm)	A(mm)	
	Max	Min
Φ6 - 6.35 (1/4")	1.3	0.7
Φ9.52 (3/8")	1.6	1.0
Φ12 - 12.70 (1/2")	1.8	1.0
Φ16 - 15.88 (5/8")	2.4	2.2

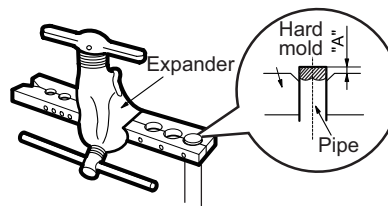

F: Inspection

- Check the quality of expanding port. If there is any blemish, expand the port again according to the steps above.

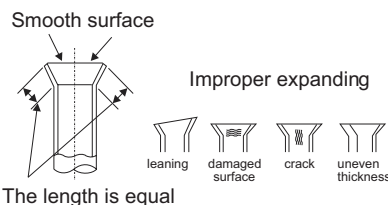

Appendix 4: List of Resistance for Temperature Sensor

Resistance Table of Ambient Temperature Sensor for Indoor and Outdoor Units(15K)

Temp(°C)	Resistance(kΩ)	Temp(°C)	Resistance(kΩ)	Temp(°C)	Resistance(kΩ)	Temp(°C)	Resistance(kΩ)
-19	138.1	20	18.75	59	3.848	98	1.071
-18	128.6	21	17.93	60	3.711	99	1.039
-17	121.6	22	17.14	61	3.579	100	1.009
-16	115	23	16.39	62	3.454	101	0.98
-15	108.7	24	15.68	63	3.333	102	0.952
-14	102.9	25	15	64	3.217	103	0.925
-13	97.4	26	14.36	65	3.105	104	0.898
-12	92.22	27	13.74	66	2.998	105	0.873
-11	87.35	28	13.16	67	2.896	106	0.848
-10	82.75	29	12.6	68	2.797	107	0.825
-9	78.43	30	12.07	69	2.702	108	0.802
-8	74.35	31	11.57	70	2.611	109	0.779
-7	70.5	32	11.09	71	2.523	110	0.758
-6	66.88	33	10.63	72	2.439	111	0.737
-5	63.46	34	10.2	73	2.358	112	0.717
-4	60.23	35	9.779	74	2.28	113	0.697
-3	57.18	36	9.382	75	2.206	114	0.678
-2	54.31	37	9.003	76	2.133	115	0.66
-1	51.59	38	8.642	77	2.064	116	0.642
0	49.02	39	8.297	78	1.997	117	0.625
1	46.6	40	7.967	79	1.933	118	0.608
2	44.31	41	7.653	80	1.871	119	0.592
3	42.14	42	7.352	81	1.811	120	0.577
4	40.09	43	7.065	82	1.754	121	0.561
5	38.15	44	6.791	83	1.699	122	0.547
6	36.32	45	6.529	84	1.645	123	0.532
7	34.58	46	6.278	85	1.594	124	0.519
8	32.94	47	6.038	86	1.544	125	0.505
9	31.38	48	5.809	87	1.497	126	0.492
10	29.9	49	5.589	88	1.451	127	0.48
11	28.51	50	5.379	89	1.408	128	0.467
12	27.18	51	5.197	90	1.363	129	0.456
13	25.92	52	4.986	91	1.322	130	0.444
14	24.73	53	4.802	92	1.282	131	0.433
15	23.6	54	4.625	93	1.244	132	0.422
16	22.53	55	4.456	94	1.207	133	0.412
17	21.51	56	4.294	95	1.171	134	0.401
18	20.54	57	4.139	96	1.136	135	0.391
19	19.63	58	3.99	97	1.103	136	0.382

Resistance Table of Tube Temperature Sensors for Indoor and Outdoor (20K)

Temp(°C)	Resistance(kΩ)	Temp(°C)	Resistance(kΩ)	Temp(°C)	Resistance(kΩ)	Temp(°C)	Resistance(kΩ)
-19	181.4	20	25.01	59	5.13	98	1.427
-18	171.4	21	23.9	60	4.948	99	1.386
-17	162.1	22	22.85	61	4.773	100	1.346
-16	153.3	23	21.85	62	4.605	101	1.307
-15	145	24	20.9	63	4.443	102	1.269
-14	137.2	25	20	64	4.289	103	1.233
-13	129.9	26	19.14	65	4.14	104	1.198
-12	123	27	18.13	66	3.998	105	1.164
-11	116.5	28	17.55	67	3.861	106	1.131
-10	110.3	29	16.8	68	3.729	107	1.099
-9	104.6	30	16.1	69	3.603	108	1.069
-8	99.13	31	15.43	70	3.481	109	1.039
-7	94	32	14.79	71	3.364	110	1.01
-6	89.17	33	14.18	72	3.252	111	0.983
-5	84.61	34	13.59	73	3.144	112	0.956
-4	80.31	35	13.04	74	3.04	113	0.93
-3	76.24	36	12.51	75	2.94	114	0.904
-2	72.41	37	12	76	2.844	115	0.88
-1	68.79	38	11.52	77	2.752	116	0.856
0	65.37	39	11.06	78	2.663	117	0.833
1	62.13	40	10.62	79	2.577	118	0.811
2	59.08	41	10.2	80	2.495	119	0.777
3	56.19	42	9.803	81	2.415	120	0.769
4	53.46	43	9.42	82	2.339	121	0.746
5	50.87	44	9.054	83	2.265	122	0.729
6	48.42	45	8.705	84	2.194	123	0.71
7	46.11	46	8.37	85	2.125	124	0.692
8	43.92	47	8.051	86	2.059	125	0.674
9	41.84	48	7.745	87	1.996	126	0.658
10	39.87	49	7.453	88	1.934	127	0.64
11	38.01	50	7.173	89	1.875	128	0.623
12	36.24	51	6.905	90	1.818	129	0.607
13	34.57	52	6.648	91	1.736	130	0.592
14	32.98	53	6.403	92	1.71	131	0.577
15	31.47	54	6.167	93	1.658	132	0.563
16	30.04	55	5.942	94	1.609	133	0.549
17	28.68	56	5.726	95	1.561	134	0.535
18	27.39	57	5.519	96	1.515	135	0.521
19	26.17	58	5.32	97	1.47	136	0.509

Resistance Table of Discharge Temperature Sensor for Outdoor(50K)

Temp(°C)	Resistance(kΩ)	Temp(°C)	Resistance(kΩ)	Temp(°C)	Resistance(kΩ)	Temp(°C)	Resistance(kΩ)
-29	853.5	10	98	49	18.34	88	4.754
-28	799.8	11	93.42	50	17.65	89	4.609
-27	750	12	89.07	51	16.99	90	4.469
-26	703.8	13	84.95	52	16.36	91	4.334
-25	660.8	14	81.05	53	15.75	92	4.204
-24	620.8	15	77.35	54	15.17	93	4.079
-23	580.6	16	73.83	55	14.62	94	3.958
-22	548.9	17	70.5	56	14.09	95	3.841
-21	516.6	18	67.34	57	13.58	96	3.728
-20	486.5	19	64.33	58	13.09	97	3.619
-19	458.3	20	61.48	59	12.62	98	3.514
-18	432	21	58.77	60	12.17	99	3.413
-17	407.4	22	56.19	61	11.74	100	3.315
-16	384.5	23	53.74	62	11.32	101	3.22
-15	362.9	24	51.41	63	10.93	102	3.129
-14	342.8	25	49.19	64	10.54	103	3.04
-13	323.9	26	47.08	65	10.18	104	2.955
-12	306.2	27	45.07	66	9.827	105	2.872
-11	289.6	28	43.16	67	9.489	106	2.792
-10	274	29	41.34	68	9.165	107	2.715
-9	259.3	30	39.61	69	8.854	108	2.64
-8	245.6	31	37.96	70	8.555	109	2.568
-7	232.6	32	36.38	71	8.268	110	2.498
-6	220.5	33	34.88	72	7.991	111	2.431
-5	209	34	33.45	73	7.726	112	2.365
-4	198.3	35	32.09	74	7.47	113	2.302
-3	199.1	36	30.79	75	7.224	114	2.241
-2	178.5	37	29.54	76	6.998	115	2.182
-1	169.5	38	28.36	77	6.761	116	2.124
0	161	39	27.23	78	6.542	117	2.069
1	153	40	26.15	79	6.331	118	2.015
2	145.4	41	25.11	80	6.129	119	1.963
3	138.3	42	24.13	81	5.933	120	1.912
4	131.5	43	23.19	82	5.746	121	1.863
5	125.1	44	22.29	83	5.565	122	1.816
6	119.1	45	21.43	84	5.39	123	1.77
7	113.4	46	20.6	85	5.222	124	1.725
8	108	47	19.81	86	5.06	125	1.682
9	102.8	48	19.06	87	4.904	126	1.64

Note: The information above is for reference only.

JF00302998



GREE ELECTRIC APPLIANCES, INC. OF ZHUHAI

Add: West Jinji Rd, Qianshan, Zhuhai, Guangdong, China 519070

Tel: (+86-756) 8522218 Fax: (+86-756) 8669426

Email: gree@gree.com.cn Http://www.gree.com

HONG KONG GREE ELECTRIC APPLIANCES SALES LIMITED

Add: Unit 2612, 26/F., Miramar Tower 132 Nathan Road, TST, Kowloon, HK

Tel: (852) 31658898 Fax: (852) 31651029

For product improvement, specifications and appearance in this manual are subject to change without prior notice.